

Power			
Fig 1	7.4.1.1	10	25
F	9.8.3.4	15	
Fig 2	7.2.1.1	6	30
C	9.1.3.4	8	
	9.4.3.2	5	
	9.9.3.2	11	
Fig 3	1.1.1.4	2	6
Add.	9.1.3.2	4	
Fig 4	7.2.3.3	6	29
A	9.9.3.6	14	
	9.2.3.4	9	
Fig 5	7.4.2.1	12	19
J	9.8.3.2	7	
Fig 6	1.2.4.2	14	29
E	9.8.2.2	9	
	9.1.5.3	6	
Fig 7	5.2.1.1	17	24
D	9.8.1.1	7	
Fig 8	1.1.6.1	10	6
Add.	9.1.1.1	6	
Fig 9	8.6.3.3	13	28
B	9.11.1.5	4	
	9.9.3.4	11	
Fig 10	8.5.5.4	10	6
Add.			
Fig 11	7.2.2.3	8	30
G	9.4.3.4	11	
	9.4.3.3	8	
	9.8.3.1	3	
Fig 12	1.2.3.1	12	30
I	9.4.2.2	7	
	9.9.5.3	11	
Fig 13	7.2.1.1	6	6
Add.			
Fig 14	2.2.3.4	26	26
H			
Total K = 294			

"@F" o88 (5,0) "@C" 1x24,2f- (-5,13) "@L" -2 (-7,0) "@A" 5x 6fa21 (9,0) "@J" o48- (1,0) "@E" 1x -48''t.3.. (-2,1) "@O" 8h (-22,0) "@L" v.4^ (-3,22) "@B" "5s.lrpf- (9,0) "@L" -ic. (-9,20) "@C" "l'44a'34'',8 (7,0) "@L" .24..t.'3f.. [-7,4] "@L" m- [-21,11] "@H" -2jo15>

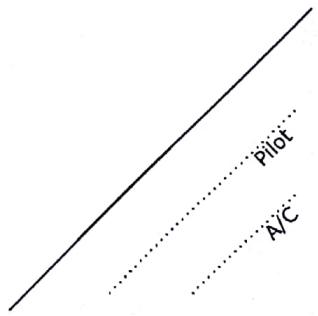

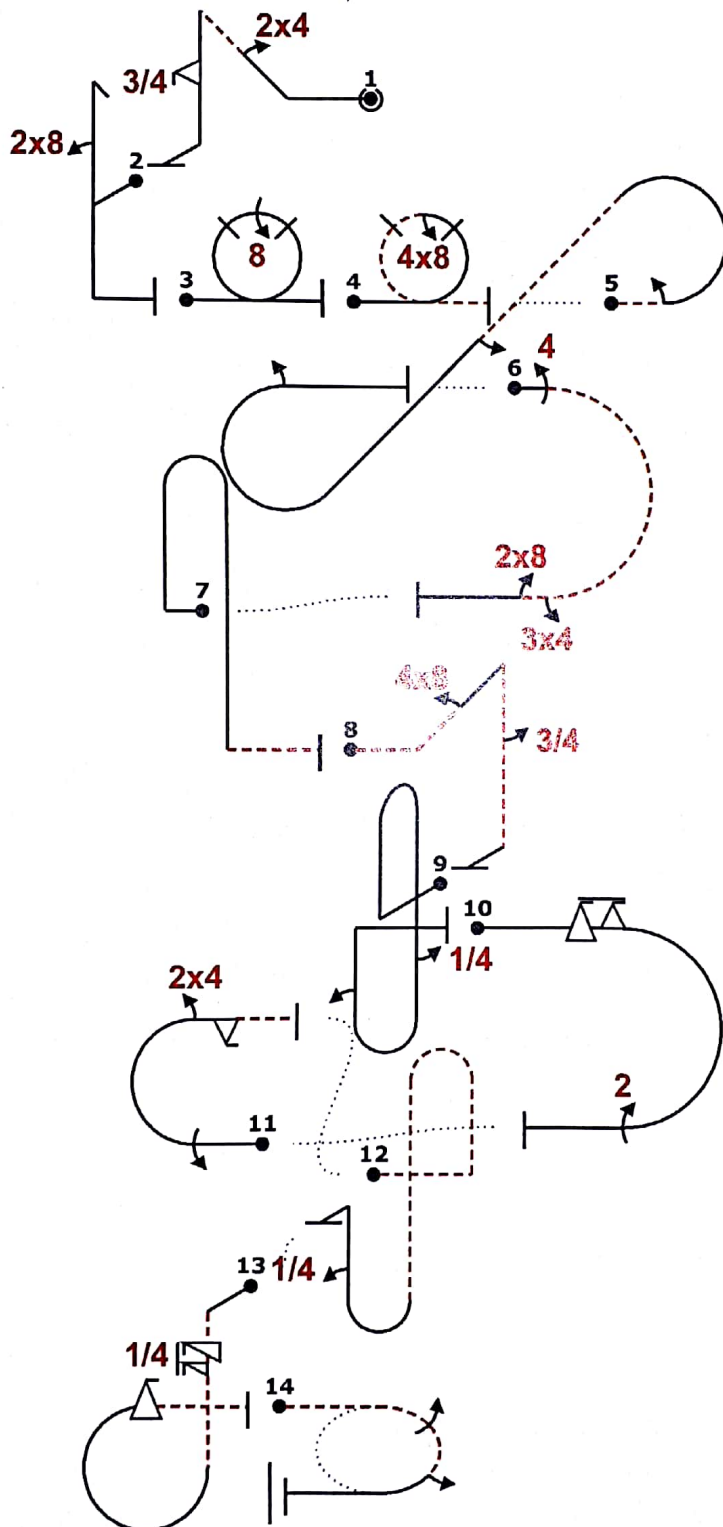
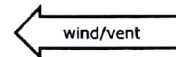

Power			
Fig 1 I	1.2.3.1 9.4.2.2 9.9.5.3	12 7 11	30
Fig 2 D	5.2.1.1 9.8.1.1	17 7	24
Fig 3 F	7.4.1.1 9.8.3.4	10 15	25
Fig 4 J	7.4.2.1 9.8.3.2	12 7	19
Fig 5 Add.	7.5.8.2 9.1.3.2 9.1.4.2 9.1.3.2	15 4 4 4	6
Fig 6 G	7.2.2.3 9.4.3.4 9.4.3.3 9.8.3.1	8 11 8 3	30
Fig 7 Add.	8.4.2.1	14	6
Fig 8 E	1.2.4.2 9.8.2.2 9.1.5.3	14 9 6	29
Fig 9 Add.	8.8.2.1 9.1.5.1 9.1.1.2	19 2 8	6
Fig 10 A	7.2.3.3 9.9.3.6 9.2.3.4	6 14 9	29
Fig 11 C	7.2.1.1 9.1.3.4 9.4.3.2 9.9.3.2	6 8 5 11	30
Fig 12 Add.	8.8.3.2 9.1.1.1	23 6	6
Fig 13 B	8.6.3.3 9.11.1.5 9.9.3.4	13 4 11	28
Fig 14 H	2.2.3.4	26	26
Total K = 294			

ed "eI" ~,24t,3f "e0" 28h "eF" -3% o88 "eJ" -3% o48- (4,0) "eL"2ac(...'2...')2+..... (3,0) "eG" 7% ...44a34,8 (-10,1)
 "eL"+b... "eC" -48t'3. "eL" bb(4)2> "eA" 6% 6fa,22 (-13,1) "eC" 1m24,2f- (1,10) "eL" -pbb4+... (-1,2) "e0" ,5sirpf- "eH" -2jo15

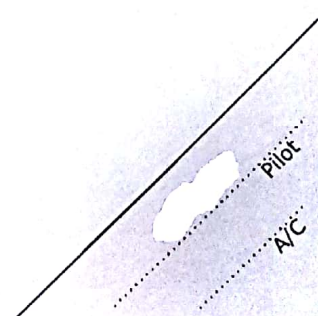

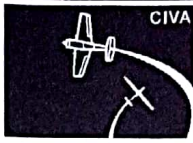

Pilot ID

D

CIVA Advanced Unknown1

Form B

Flight #

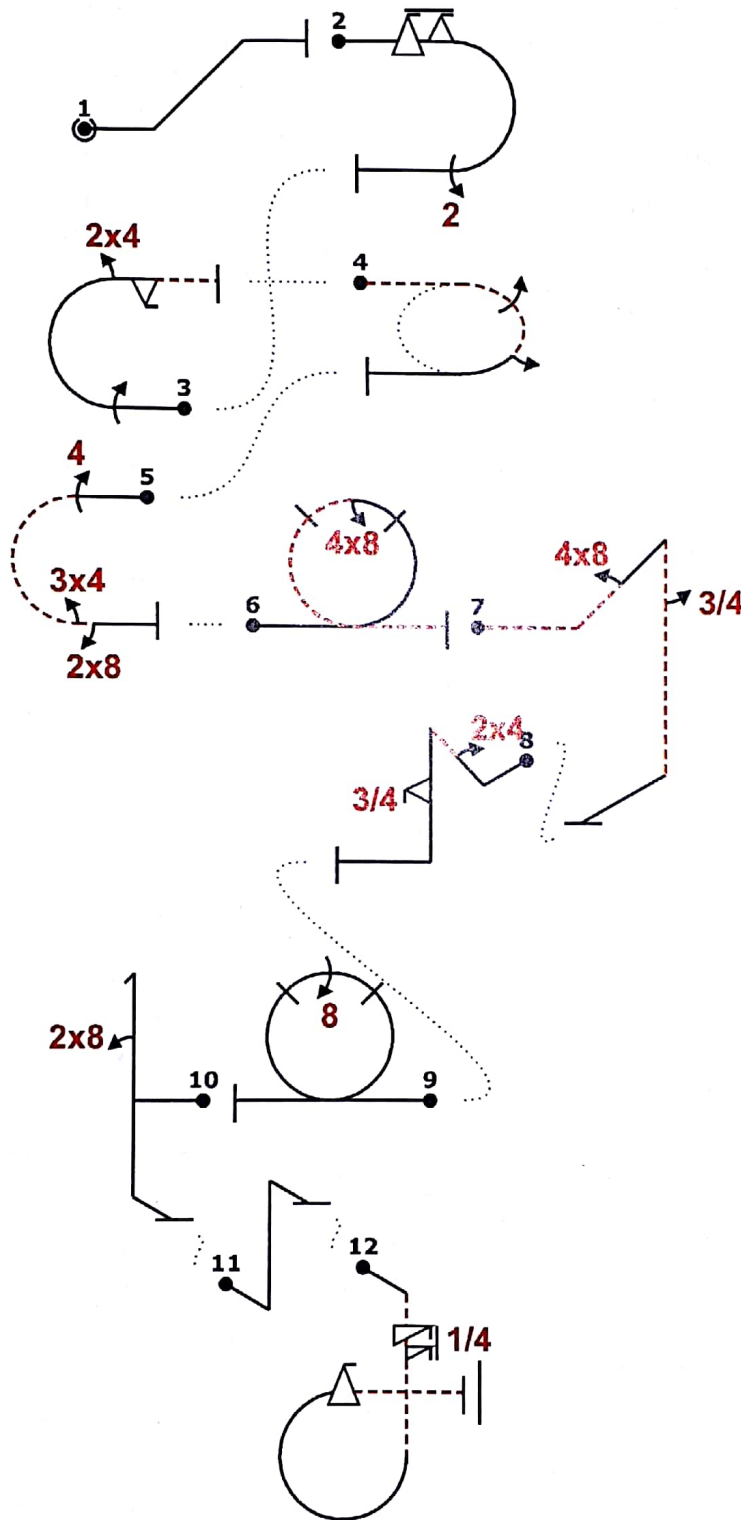
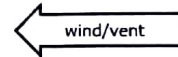

Power			
Fig 1	1.1.2.1	7	12
Fig 2 A	7.2.3.3	6	29
	9.9.3.6	14	
	9.2.3.4	9	
Fig 3 C	7.2.1.1	6	30
	9.1.3.4	8	
	9.4.3.2	5	
	9.9.3.2	11	
Fig 4 H	2.2.3.4	26	26
Fig 5 G	7.2.2.3	8	30
	9.4.3.4	11	
	9.4.3.3	8	
	9.8.3.1	3	
Fig 6 J	7.4.2.1	12	19
	9.8.3.2	7	
Fig 7 E	1.2.4.2	14	29
	9.8.2.2	9	
	9.1.5.3	6	
Fig 8 I	1.2.3.1	12	30
	9.4.2.2	7	
	9.9.5.3	11	
Fig 9 F	7.4.1.1	10	25
	9.8.3.4	15	
Fig 10 D	5.2.1.1	17	24
	9.8.1.1	7	
Fig 11 Add.	1.1.6.1	10	12
Fig 12 B	8.6.3.3	13	28
	9.11.1.5	4	
	9.9.3.4	11	
Total K = 294			

"@L" d "0A" 6fa22-- (-7,15) "0C" ,1m24,2f- (5,0) "0H" -2j015 (-10,8) "0G" ,44a34,8 (2,0) "0J" o48- "0E" ---48t3..' +-- (0,-6) "0I" ,24t,3 f-- (10,15) "0F" o,88 "0D" /8h (0,2) "0L" v (0,2) "0B" Ss1rpf--

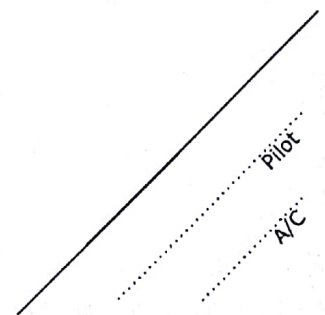

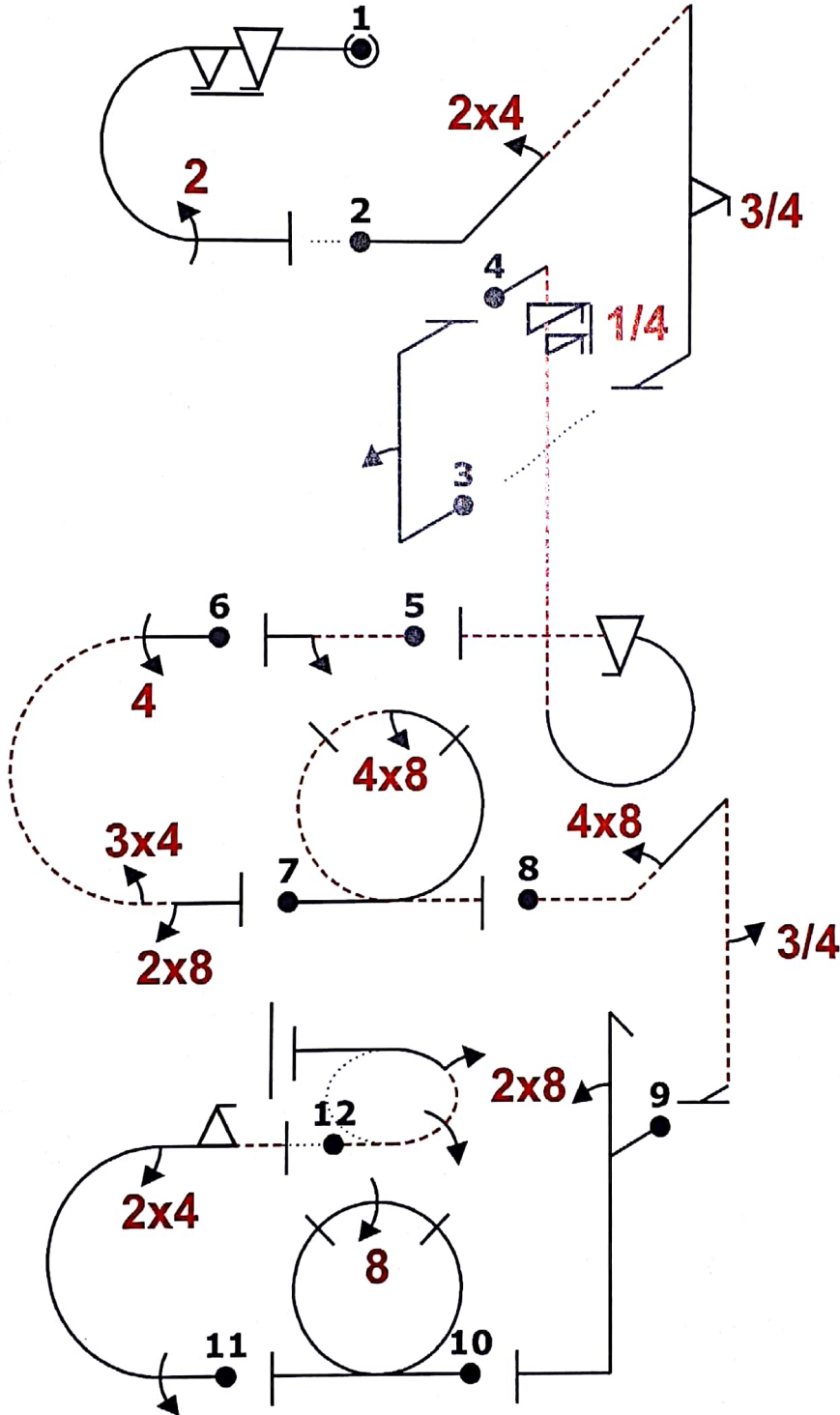
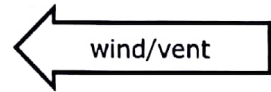

Power			
Fig 1 A	7.2.3.3	6	29
	9.9.3.6	14	
	9.2.3.4	9	
Fig 2 I	1.2.3.1	12	30
	9.4.2.2	7	
	9.9.5.3	11	
Fig 3 Add.	1.1.6.1	10	12
	9.1.1.2	8	
Fig 4 B	8.6.3.3	13	28
	9.11.1.5	4	
	9.9.3.4	11	
Fig 5 Add.	1.1.1.4	2	12
	9.1.3.2	4	
Fig 6 G	7.2.2.3	8	30
	9.4.3.4	11	
	9.4.3.3	8	
	9.8.3.1	3	
Fig 7 J	7.4.2.1	12	19
	9.8.3.2	7	
Fig 8 E	1.2.4.2	14	29
	9.8.2.2	9	
	9.1.5.3	6	
Fig 9 D	5.2.1.1	17	24
	9.8.1.1	7	
Fig 10 F	7.4.1.1	10	25
	9.8.3.4	15	
Fig 11 C	7.2.1.1	6	30
	9.1.3.4	8	
	9.4.3.2	5	
	9.9.3.2	11	
Fig 12 H	2.2.3.4	26	26
Total K = 294			

ed "BA" 6fa22 (-1,0) "BI" '24.'t.'3f' (-4,3) "BL" v2 -2% "BM" 5s....'lmpf--- "BN" -2' 4% "BO" '44a34,8+' "BP" '++048-' "BQ" -' 48t
 '3'+' "BR" +8 h. -1% "BS" '++0,88+' 2% "BT" '1m,24,2f-' (-2,0) -3% "BU" '---2j015>

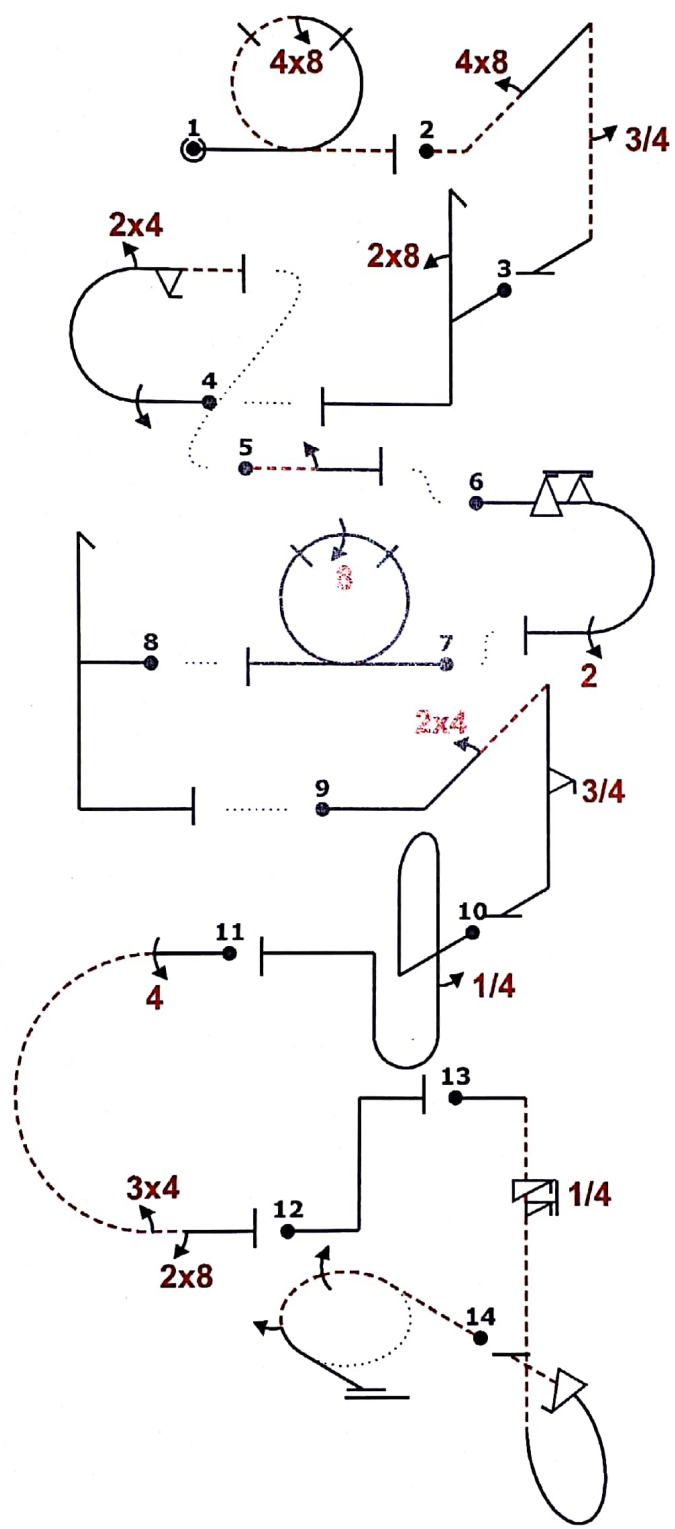
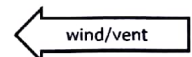

Power			
Fig 1 J	7.4.2.1 9.8.3.2	12 7	19
Fig 2 E	1.2.4.2 9.8.2.2 9.1.5.3	14 9 6	29
Fig 3 D	5.2.1.1 9.8.1.1	17 7	24
Fig 4 C	7.2.1.1 9.1.3.4 9.4.3.2 9.9.3.2	6 8 5 11	30
Fig 5 Add.	1.1.1.4 9.1.3.2	2 4	6
Fig 6 A	7.2.3.3 9.9.3.6 9.2.3.4	6 14 9	29
Fig 7 F	7.4.1.1 9.8.3.4	10 15	25
Fig 8 Add.	5.2.1.1	17	6
Fig 9 I	1.2.3.1 9.4.2.2 9.9.5.3	12 7 11	30
Fig 10 Add.	8.8.2.1 9.1.5.1	19 2	6
Fig 11 G	7.2.2.3 9.4.3.4 9.4.3.3 9.8.3.1	8 11 8 3	30
Fig 12 Add.	1.1.6.1	10	6
Fig 13 B	8.6.3.3 9.11.1.5 9.9.3.4	13 4 11	28
Fig 14 H	2.2.3.4	26	26
Total K = 294			

"@J" o48- "QE" "'-48't.3'~ "GO" ~8h'~ (-3,0) "OC" 1m24,2f- (-4,12) "OL" -2 (2,2) "EA" 6fa22 (-1,2) "EF" o,88 (-2,0) "EL" h.+ (4,0)
 "EI" ~'24't'3f'~ "EL" ~bb('4)~ "EG" 11x' 44a34,8~ "EL" v "EO" /5s..irpf-^ "EH" --2jo15>

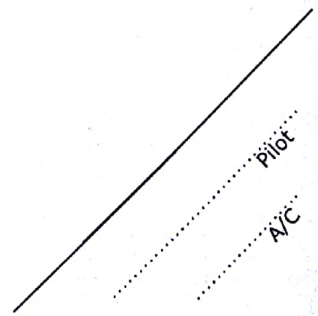

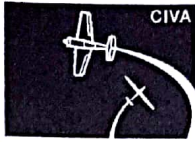

Pilot ID

G

CIVA Advanced Unknown1

Form B

Flight #

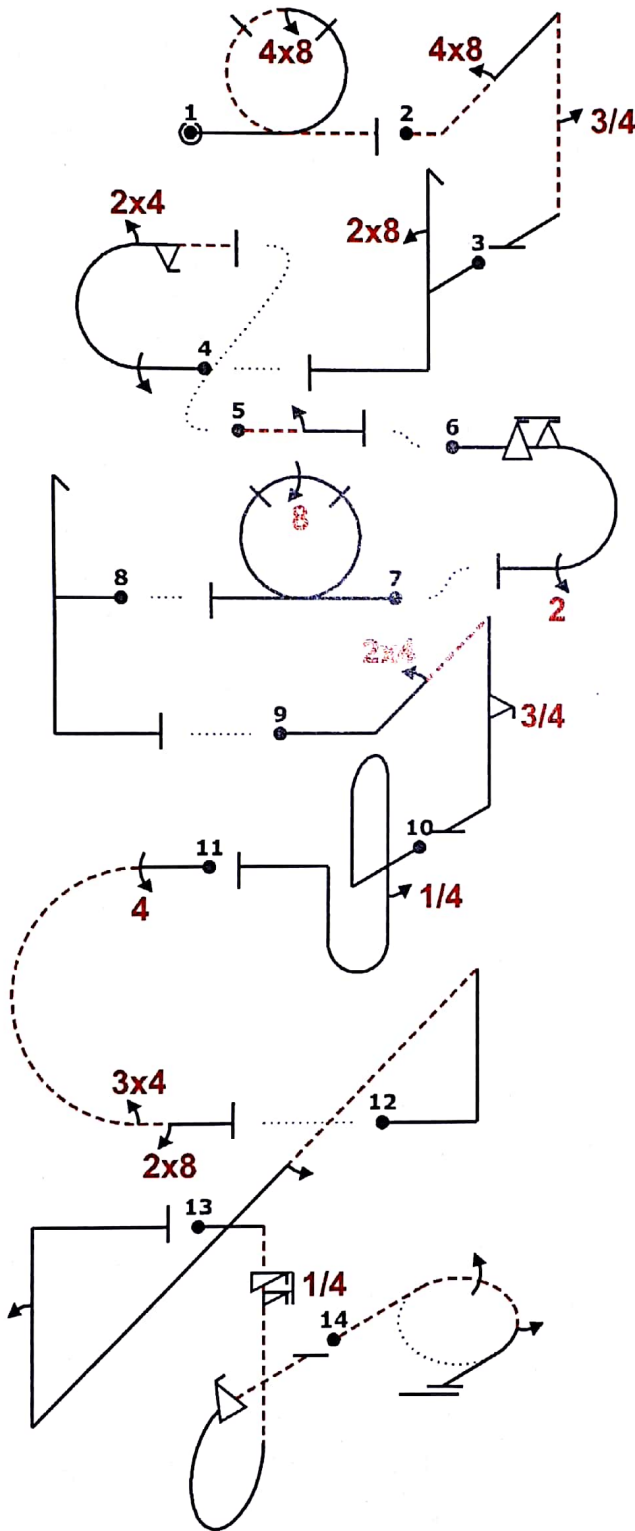
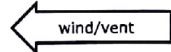

Power			
Fig 1 J	7.4.2.1 9.8.3.2	12 7	19
Fig 2 E	1.2.4.2 9.8.2.2 9.1.5.3	14 9 6	29
Fig 3 D	5.2.1.1 9.8.1.1	17 7	24
Fig 4 C	7.2.1.1 9.1.3.4 9.4.3.2 9.9.3.2	6 8 5 11	30
Fig 5 Add.	1.1.1.4 9.1.3.2	2 4	6
Fig 6 A	7.2.3.3 9.9.3.6 9.2.3.4	6 14 9	29
Fig 7 F	7.4.1.1 9.8.3.4	10 15	25
Fig 8 Add.	5.2.1.1	17	6
Fig 9 I	1.2.3.1 9.4.2.2 9.9.5.3	12 7 11	30
Fig 10 Add.	8.8.2.1 9.1.5.1	19 2	6
Fig 11 G	7.2.2.3 9.4.3.4 9.4.3.3 9.8.3.1	8 11 8 3	30
Fig 12 Add.	1.3.12.1 9.1.4.2 9.1.1.2	21 4 8	6
Fig 13 B	8.6.3.3 9.11.1.5 9.9.3.4	13 4 11	28
Fig 14 H	2.2.3.4	26	26
Total K = 294			

"@J" o48- "BE" "'-48't.3'~ "80" ~8h~ (-3,0) "8C" 1m24,2f- (-4,12) "@L" -2 (2,1) "8A" 6fa22 (-3,2) "8F" o,88 (-2,0) "8L" h.+ (4,0)
 "@I" ~'24't'3f'~ "8L" ~bb('4') "8C" 11X '44a34,8~ (6,0) "8L" ~n(...'2.....)'2'~ "8B" '5s.1rpf~ "8H" ~2jo15

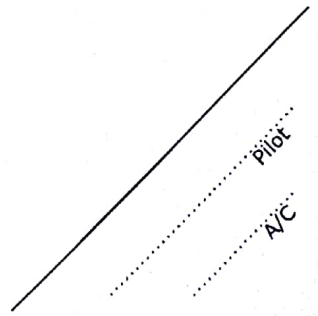

Pilot ID **H**

Strejnic 13-08-2018

Form B

CIVA Advanced Unknown1

Flight #

wind/vent ←

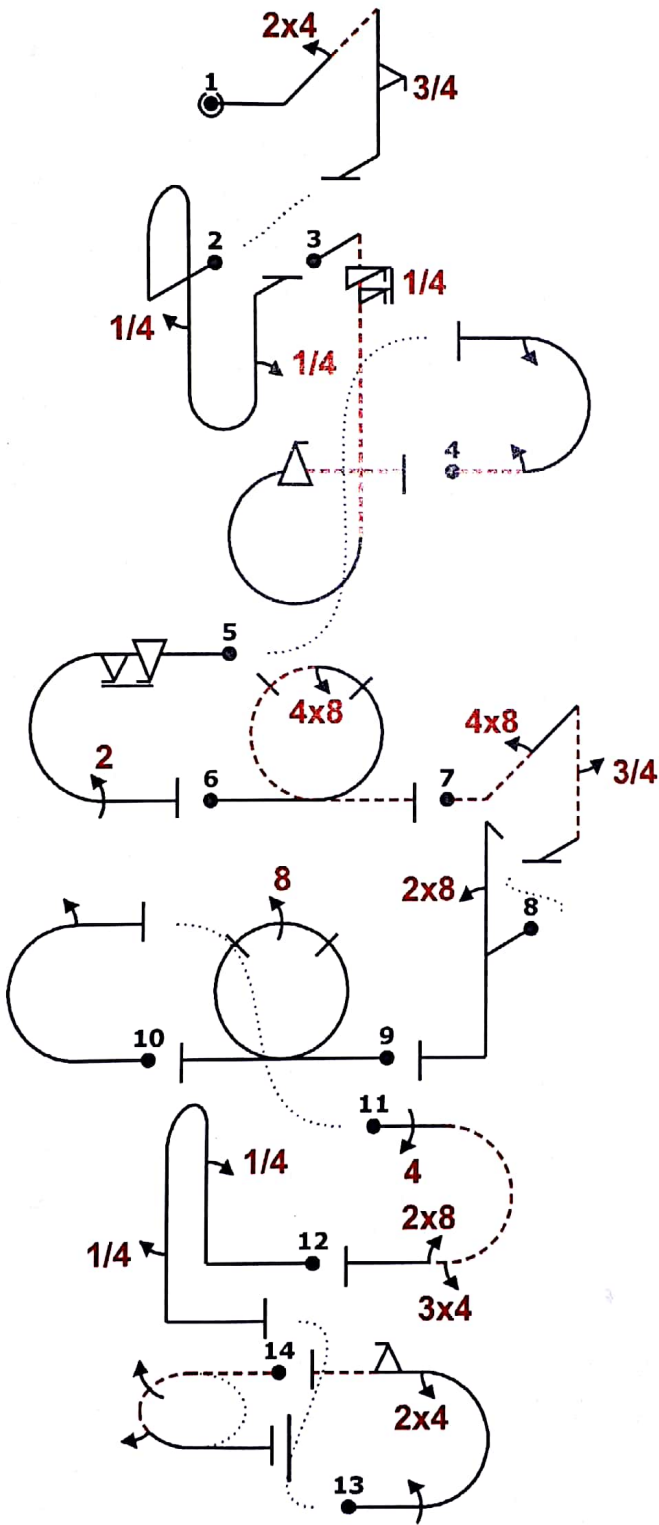

Power			
Fig 1 I	1.2.3.1 9.4.2.2 9.9.5.3	12 7 11	30
Fig 2 Add.	8.8.2.1 9.1.5.1 9.1.1.1	19 2 6	6
Fig 3 B	8.6.3.3 9.11.1.5 9.9.3.4	13 4 11	28
Fig 4 Add.	7.2.4.2 9.1.3.2 9.1.3.2	6 4 4	6
Fig 5 A	7.2.3.3 9.9.3.6 9.2.3.4	6 14 9	29
Fig 6 J	7.4.2.1 9.8.3.2	12 7	19
Fig 7 E	1.2.4.2 9.8.2.2 9.1.5.3	14 9 6	29
Fig 8 D	5.2.1.1 9.8.1.1	17 7	24
Fig 9 F	7.4.1.1 9.8.3.4	10 15	25
Fig 10 Add.	7.2.2.1 9.1.3.2	6 4	6
Fig 11 G	7.2.2.3 9.4.3.4 9.4.3.3 9.8.3.1	8 11 8 3	30
Fig 12 Add.	8.4.1.1 9.1.1.1 9.1.5.1	13 6 2	6
Fig 13 C	7.2.1.1 9.1.3.4 9.4.3.2 9.9.3.2	6 8 5 11	30
Fig 14 H	2.2.3.4	26	26
Total K = 294			

"@I" 24t3f (-4,3) "@L" "bb('',4),4+'> "@B" 5s...'lrpf-> "@L" > -2m2 (-10,19) "@A" 1% 6fa22 "@J" o48- "@E" "'-48t3 (3,2) "@D" 8h "@F" o88 "@L" m2 (10,12) "@G" ",44" a34,8- "@L" ,4b,4 (1,11) "@C" 1m24,2f- "@I" -2X -2j015

Pilot
A/C

Pilot ID

CIVA Advanced Programme2

Flight #

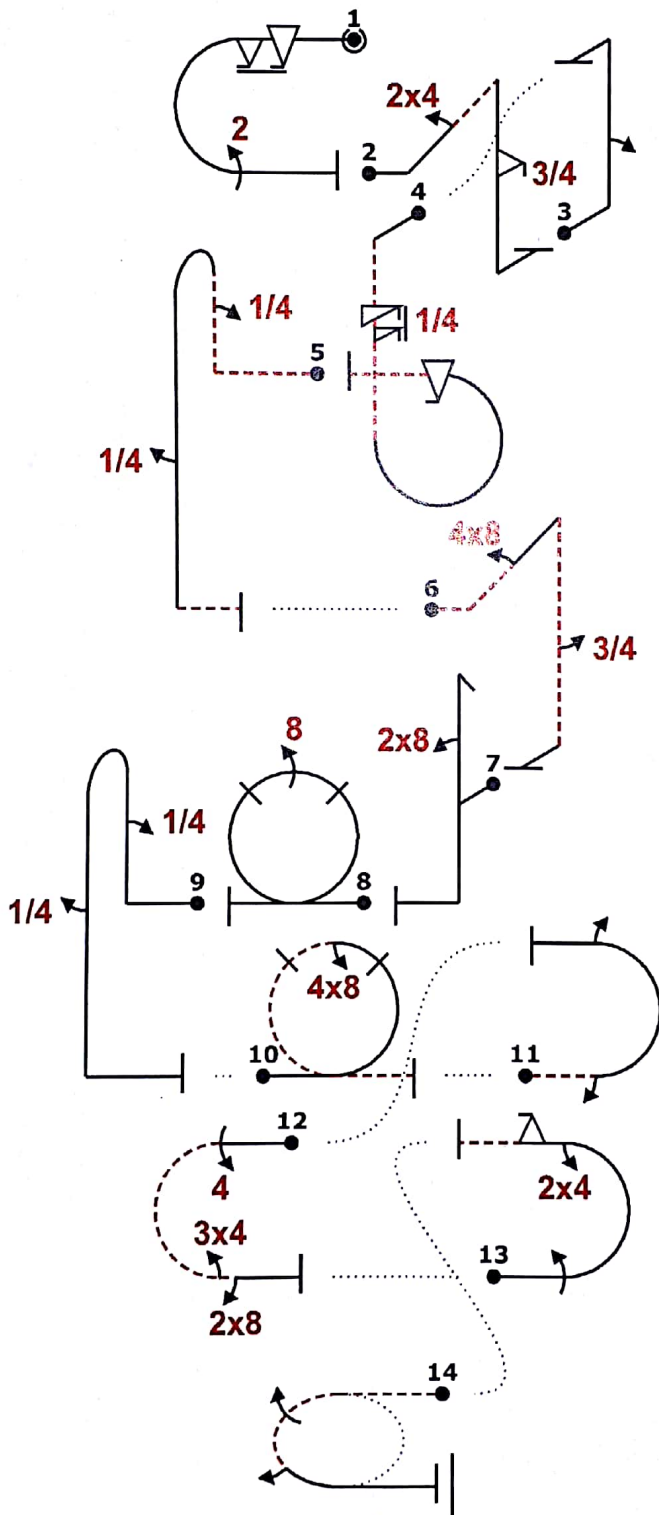

Power			
Fig 1 A	7.2.3.3	6	29
	9.9.3.6	14	
	9.2.3.4	9	
Fig 2 I	1.2.3.1	12	30
	9.4.2.2	7	
	9.9.5.3	11	
Fig 3 Add.	1.1.6.1	10	6
	9.1.1.2	8	
Fig 4 B	8.6.3.3	13	28
	9.11.1.5	4	
	9.9.3.4	11	
Fig 5 Add.	8.4.3.2	16	6
	9.1.1.1	6	
	9.1.5.1	2	
Fig 6 E	1.2.4.2	14	29
	9.8.2.2	9	
	9.1.5.3	6	
Fig 7 D	5.2.1.1	17	24
	9.8.1.1	7	
Fig 8 F	7.4.1.1	10	25
	9.8.3.4	15	
Fig 9 Add.	8.4.1.1	13	6
	9.1.1.1	6	
	9.1.5.1	2	
Fig 10 J	7.4.2.1	12	19
	9.8.3.2	7	
Fig 11 Add.	7.2.4.2	6	6
	9.1.3.2	4	
	9.1.3.2	4	
Fig 12 G	7.2.2.3	8	30
	9.4.3.4	11	
	9.4.3.3	8	
	9.8.3.1	3	
Fig 13 C	7.2.1.1	6	30
	9.1.3.4	8	
	9.4.3.2	5	
	9.9.3.2	11	
Fig 14 H	2.2.3.4	26	26
Total K = 294			

ed "0A" 6fa22-- "0I" +24t'3f' "0L" v,2' (-6,7) "00" '5s1npf-' "0L" -,4b.,4. (8,0) "0E" -48t.'3' "00" +8h "0F" +o88+ "0L" +,4'b',4.. (1,0) "0J" +o48- (3,0) "0L" -,2m,2 (-11,12) "0G" 44a34,8 (8,0) "0C" 1n24,2f- (3,15) "0H" -2jo15

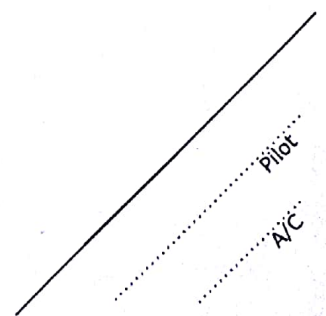

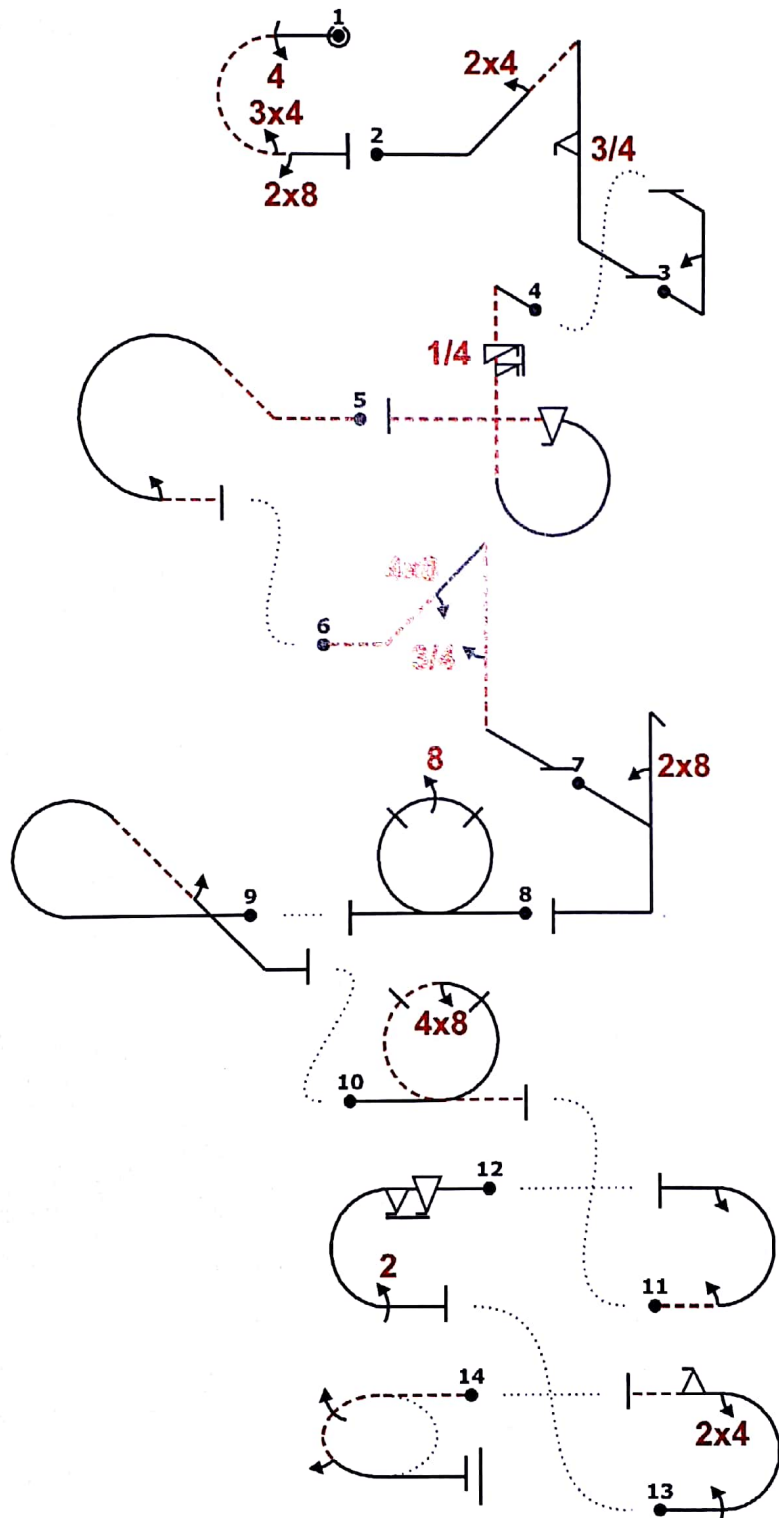
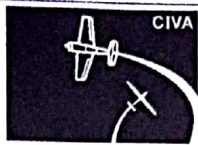

Power			
Fig 1	7.2.2.3 9.4.3.4 9.4.3.3 9.8.3.1	8 11 8 3	30
Fig 2	1.2.3.1 9.4.2.2 9.9.5.3	12 7 11	30
Fig 3	1.1.6.1 9.1.1.2	10 8	6
Fig 4	8.6.3.3 9.11.1.5 9.9.3.4	13 4 11	28
Fig 5	8.5.3.2 9.1.3.2	11 4	6
Fig 6	1.2.4.2 9.8.2.2 9.1.5.3	14 9 6	29
Fig 7	5.2.1.1 9.8.1.1	17 7	24
Fig 8	7.4.1.1 9.8.3.4	10 15	25
Fig 9	8.5.6.1 9.1.4.2	10 4	6
Fig 10	7.4.2.1 9.8.3.2	12 7	19
Fig 11	7.2.4.2 9.1.3.2 9.1.3.2	6 4 4	6
Fig 12	7.2.3.3 9.9.3.6 9.2.3.4	6 14 9	29
Fig 13	7.2.1.1 9.1.3.4 9.4.3.2 9.9.3.2	6 8 5 11	30
Fig 14	2.2.3.4	26	26
Total K = 294			

ed "0G" /44a34,8 "0I" ~~~24't.,|"3f" + "0L" v2' (-6,10) "08" ""|"5s'1mpf--- "0L" 4Xrc2..... (3,10) "0E" -',|"48' t.,'3'+ "0D" ~~~|"8h+ "0F" o88 (-3,0) "0L" ..c..'2'+ (-1,9) "0J" o48- (5,14) "0L" -2m2 (-8,0) "0A" 6fa22 (11,14) "0C" 1m24,2f- (-7,0) "0H" -2jo15

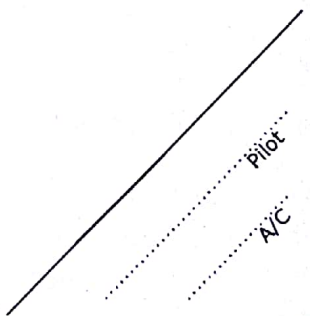

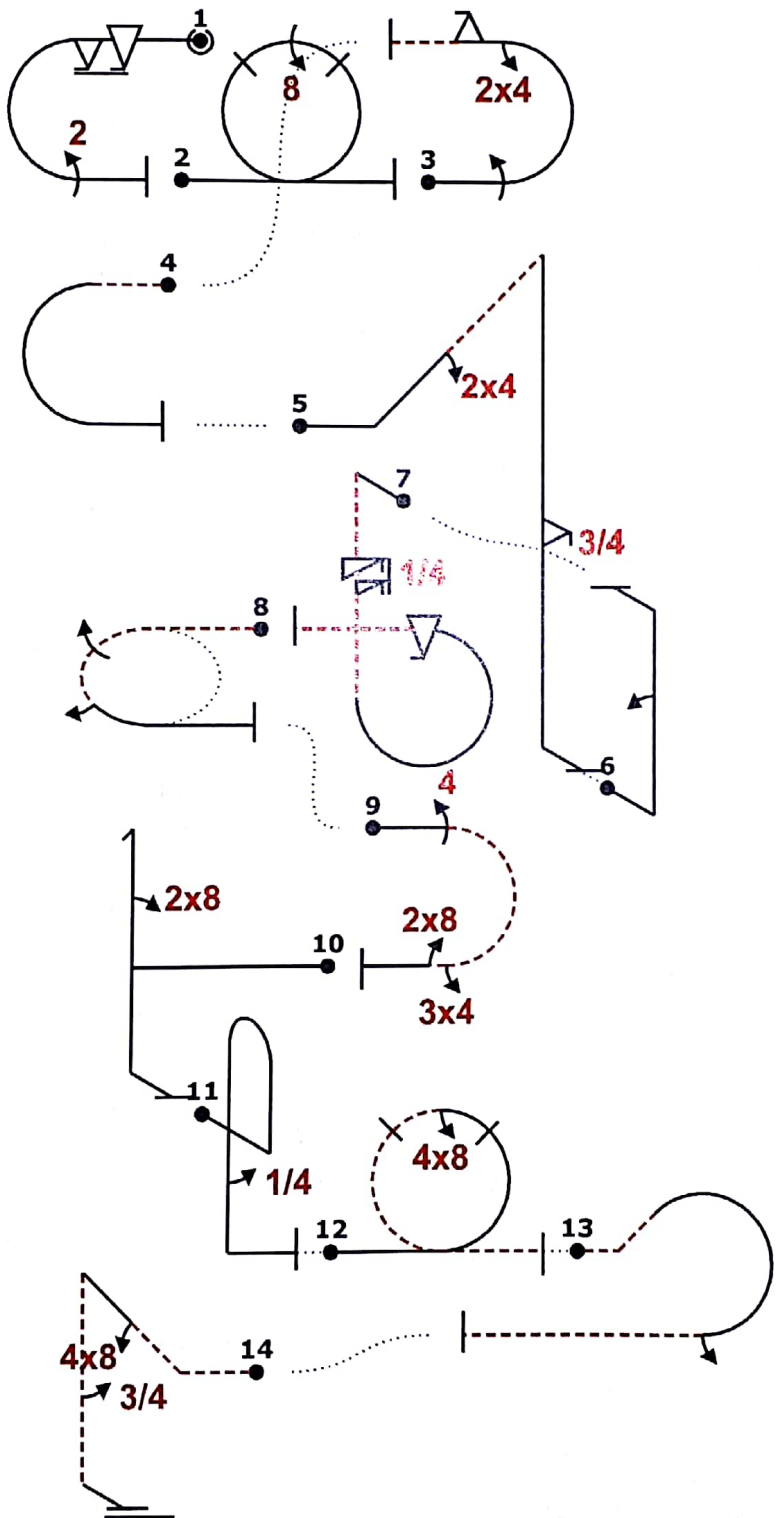

Power			
Fig 1 A	7.2.3.3	6	29
	9.9.3.6	14	
	9.2.3.4	9	
Fig 2 F	7.4.1.1	10	25
	9.8.3.4	15	
Fig 3 C	7.2.1.1	6	30
	9.1.3.4	8	
	9.4.3.2	5	
	9.9.3.2	11	
Fig 4 Add.	7.2.1.4	6	6
Fig 5 I	1.2.3.1	12	30
	9.4.2.2	7	
	9.9.5.3	11	
Fig 6 Add.	1.1.6.1	10	6
	9.1.1.2	8	
Fig 7 B	8.6.3.3	13	28
	9.1.1.5	4	
	9.9.3.4	11	
Fig 8 H	2.2.3.4	26	26
Fig 9 G	7.2.2.3	8	30
	9.4.3.4	11	
	9.4.3.3	8	
	9.8.3.1	3	
Fig 10 D	5.2.1.1	17	24
	9.8.1.1	7	
Fig 11 Add.	8.4.1.1	13	6
	9.1.5.1	2	
Fig 12 J	7.4.2.1	12	19
	9.8.3.2	7	
Fig 13 Add.	8.5.3.2	11	6
	9.1.3.2	4	
Fig 14 E	1.2.4.2	14	29
	9.8.2.2	9	
	9.1.5.3	6	
Total K = 294			

ed "@A" /6fa22 "@F" o88 "@C" 1m24,2f- (-9,14) "@L" -a (4,0) "@I" ',,24.'t....3f...' (-2,-1) "@L" v.2' (-9,-3) "@B" .5s1rpf~ "@H" -2jo15 (3,6) "@G" 44a34,B "@D" ~+,8h "@L" 'b''4+ (-2,0) "@J" o48- (-2,0) "@L"rc2- (-8,2) "@E" -48t.3'

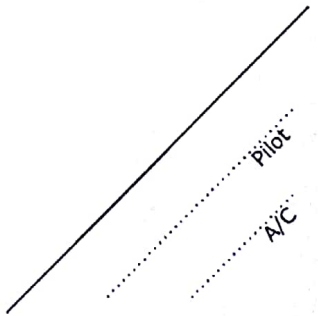



Strejnic 15-25 August

Pilot ID **L** CIVA Advanced Unknown1

Form B

Flight #

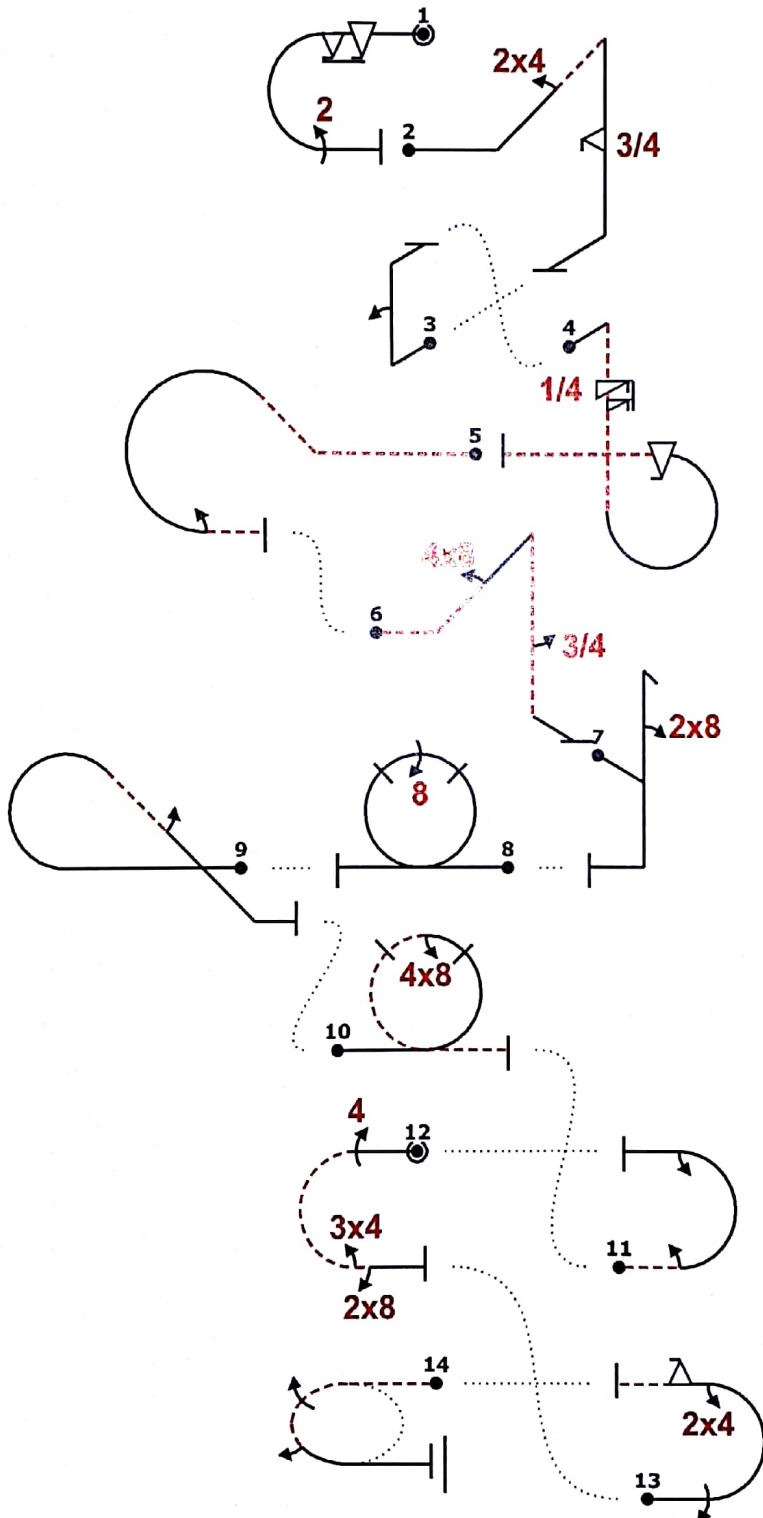

Power			
Fig 1 A	7.2.3.3	6	29
	9.9.3.6	14	
	9.2.3.4	9	
Fig 2 I	1.2.3.1	12	30
	9.4.2.2	7	
	9.9.5.3	11	
Fig 3 Add.	1.1.6.1	10	6
	9.1.1.2	8	
Fig 4 B	8.6.3.3	13	28
	9.11.1.5	4	
	9.9.3.4	11	
Fig 5 Add.	8.5.3.2	11	6
	9.1.3.2	4	
Fig 6 E	1.2.4.2	14	29
	9.8.2.2	9	
	9.1.5.3	6	
Fig 7 D	5.2.1.1	17	24
	9.8.1.1	7	
Fig 8 F	7.4.1.1	10	25
	9.8.3.4	15	
Fig 9 Add.	8.5.6.1	10	6
	9.1.4.2	4	
Fig 10 J	7.4.2.1	12	19
	9.8.3.2	7	
Fig 11 Add.	7.2.4.2	6	6
	9.1.3.2	4	
	9.1.3.2	4	
Fig 12 G	7.2.2.3	8	30
	9.4.3.4	11	
	9.4.3.3	8	
	9.8.3.1	3	
Fig 13 C	7.2.1.1	6	30
	9.1.3.4	8	
	9.4.3.2	5	
	9.9.3.2	11	
Fig 14 H	2.2.3.4	26	26
Total K = 294			

ed (-8,0) "0A" 6fa22 "0I" ~'24't..'|'3f'it (-5,3) "0L" v2 (7,9) "00" '||'5s'lrpf--- "0L" 4% ---.....rc2----- (4,7) "0E" /-48't.'3~ "00" ~,8h (-2,0) "0F" 0,88 (-3,0) "0L" 'c.2* (-1,9) "0J" 048- (4,15) "0L" -2n2 (-11,0) ed "0G" /,44a34,8 (12,16) "0C" ,1 m34,2f- (-9,0) "0H" -2jo15

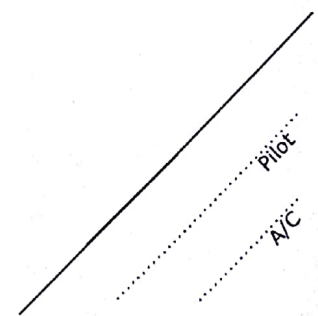

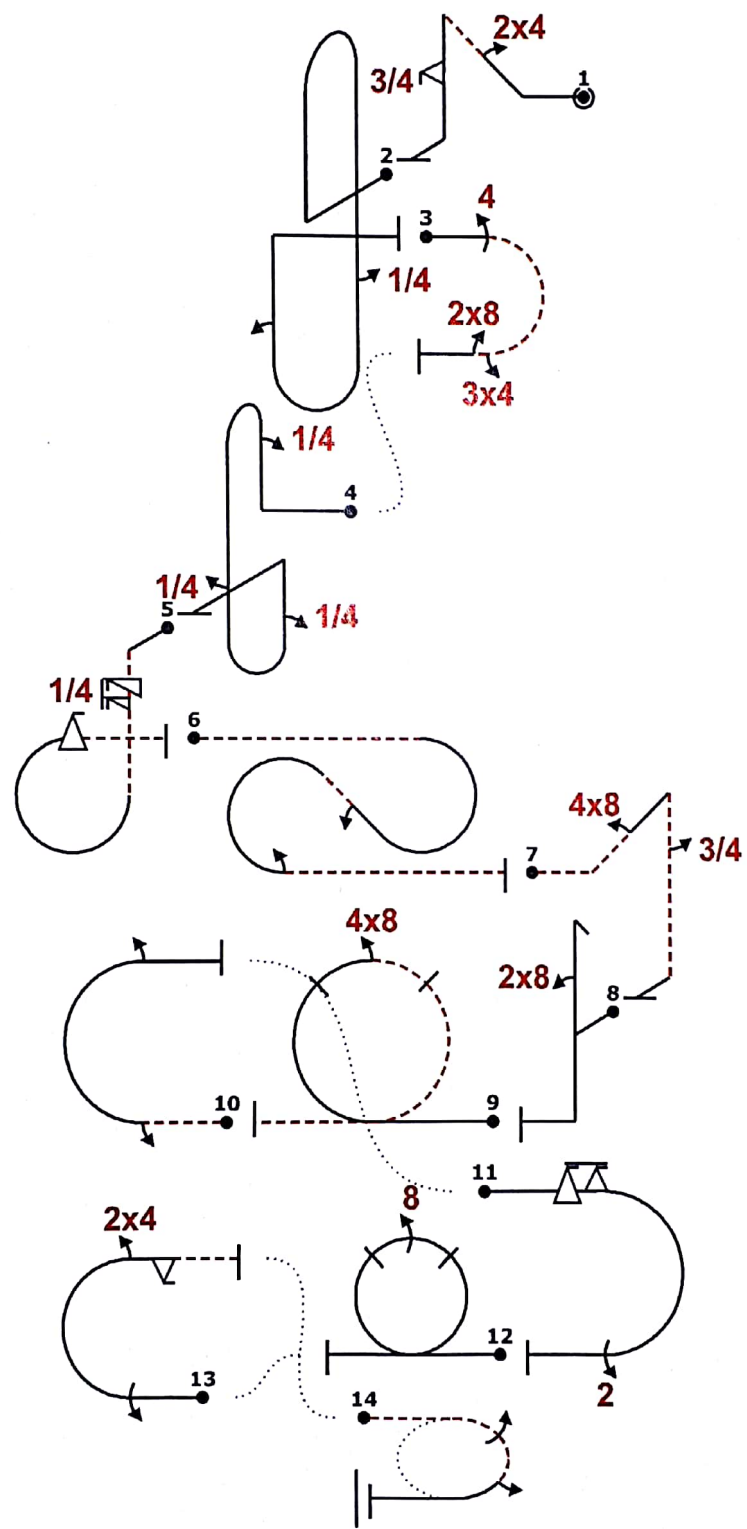

Power			
Fig 1 I	1.2.3.1	12	30
	9.4.2.2	7	
	9.9.5.3	11	
Fig 2 Add.	8.8.2.1	19	6
	9.1.5.1	2	
	9.1.1.2	8	
Fig 3 G	7.2.2.3	8	30
	9.4.3.4	11	
	9.4.3.3	8	
	9.8.3.1	3	
Fig 4 Add.	8.8.2.1	19	6
	9.1.1.1	6	
	9.1.5.1	2	
	9.1.1.1	6	
Fig 5 B	8.6.3.3	13	28
	9.1.1.5	4	
	9.9.3.4	11	
Fig 6 Add.	7.5.7.4	15	6
	9.1.2.2	6	
	9.1.3.2	4	
Fig 7 E	1.2.4.2	14	29
	9.8.2.2	9	
	9.1.5.3	6	
Fig 8 D	5.2.1.1	17	24
	9.8.1.1	7	
Fig 9 J	7.4.2.1	12	19
	9.8.3.2	7	
Fig 10 Add.	7.2.4.2	6	6
	9.1.3.2	4	
	9.1.3.2	4	
Fig 11 A	7.2.3.3	6	29
	9.9.3.6	14	
	9.2.3.4	9	
Fig 12 F	7.4.1.1	10	25
	9.8.3.4	15	
Fig 13 C	7.2.1.1	6	30
	9.1.3.4	8	
	9.4.3.2	5	
	9.9.3.2	11	
Fig 14 H	2.2.3.4	26	26
Total K = 294			

ed "0I" ,24t,3f "0L" 5% bb(4)2 "0G" 44a34,28 (-1,11) "0L" ,4bb(,4),4+~ "0B" ,5s1rpf-> "0L" -iac(2)2- "0E" -48t3.' "0D" 28h "0J" 4% o48
 - "@L" 4% -2m2 (15,16) "0A" 4% 6fa22 "0F" o88 (-5,3) "0C" 2% 1m24,2f- (5,11) "0H" -2j015

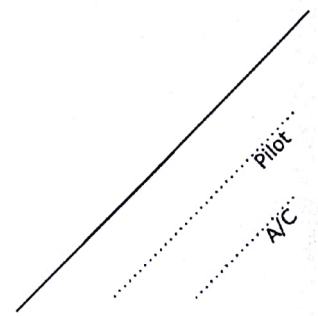



Pilot ID N		WAAC 2018	Form B
		CIVA Advanced Unknown1	Flight #

wind/vent ←

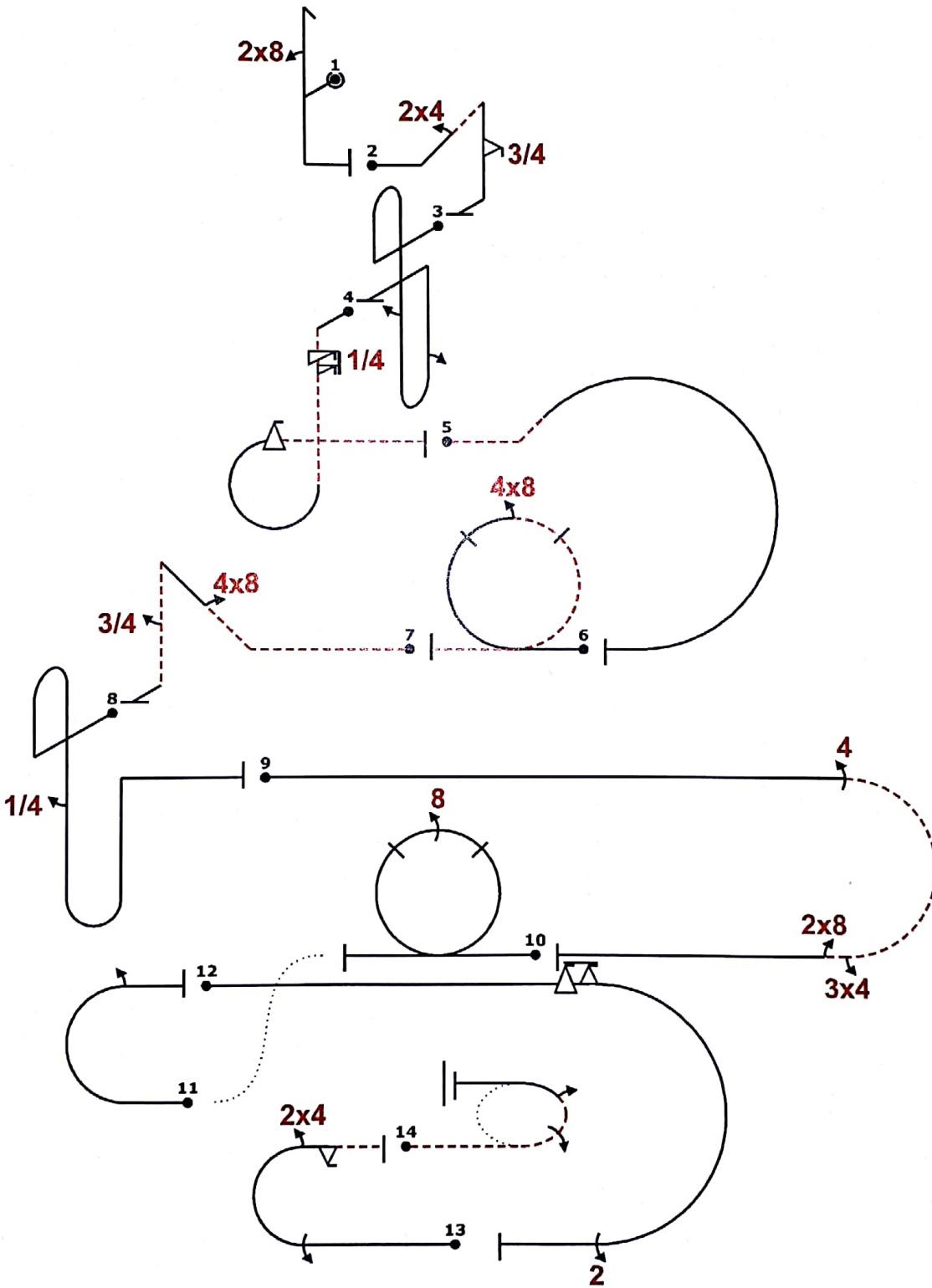

Power			
Fig 1 D	5.2.1.1 9.8.1.1	17 7	24
Fig 2 I	1.2.3.1 9.4.2.2 9.9.5.3	12 7 11	30
Fig 3 Add.	8.8.2.1 9.1.5.2 9.1.1.2	19 4 8	6
Fig 4 B	8.6.3.3 9.1.1.5 9.9.3.4	13 4 11	28
Fig 5 Add.	8.5.1.2	10	6
Fig 6 J	7.4.2.1 9.8.3.2	12 7	19
Fig 7 E	1.2.4.2 9.8.2.2 9.1.5.3	14 9 6	29
Fig 8 Add.	8.8.2.1 9.1.5.1	19 2	6
Fig 9 G	7.2.2.3 9.4.3.4 9.4.3.3 9.8.3.1	8 11 8 3	30
Fig 10 F	7.4.1.1 9.8.3.4	10 15	25
Fig 11 Add.	7.2.2.1 9.1.3.2	6 4	6
Fig 12 A	7.2.3.3 9.9.3.6 9.2.3.4	6 14 9	29
Fig 13 C	7.2.1.1 9.1.3.4 9.4.3.2 9.9.3.2	6 8 5 11	30
Fig 14 H	2.2.3.4	26	26
Total K = 294			

ej "00" 8h "0I" 24t3F "0L" + "bb(,2,).2." + "00" 5s. /lnpf----> 21X "0L" nca "0J" 5X "1"to48-" "0E" 4X --- 4 8t,3+ "0L" 2X + "bb(,4,).+ 10% "0G" "44a34,8+--- "0F" 4X 088 (-10,13) "0L" 3X m2 19X "0A" ..'6fa22+ 2> "0C" 1X ..'1m24,2f- "0 H" ---2jo15>

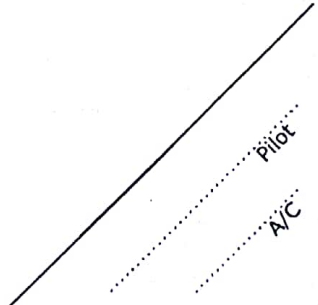

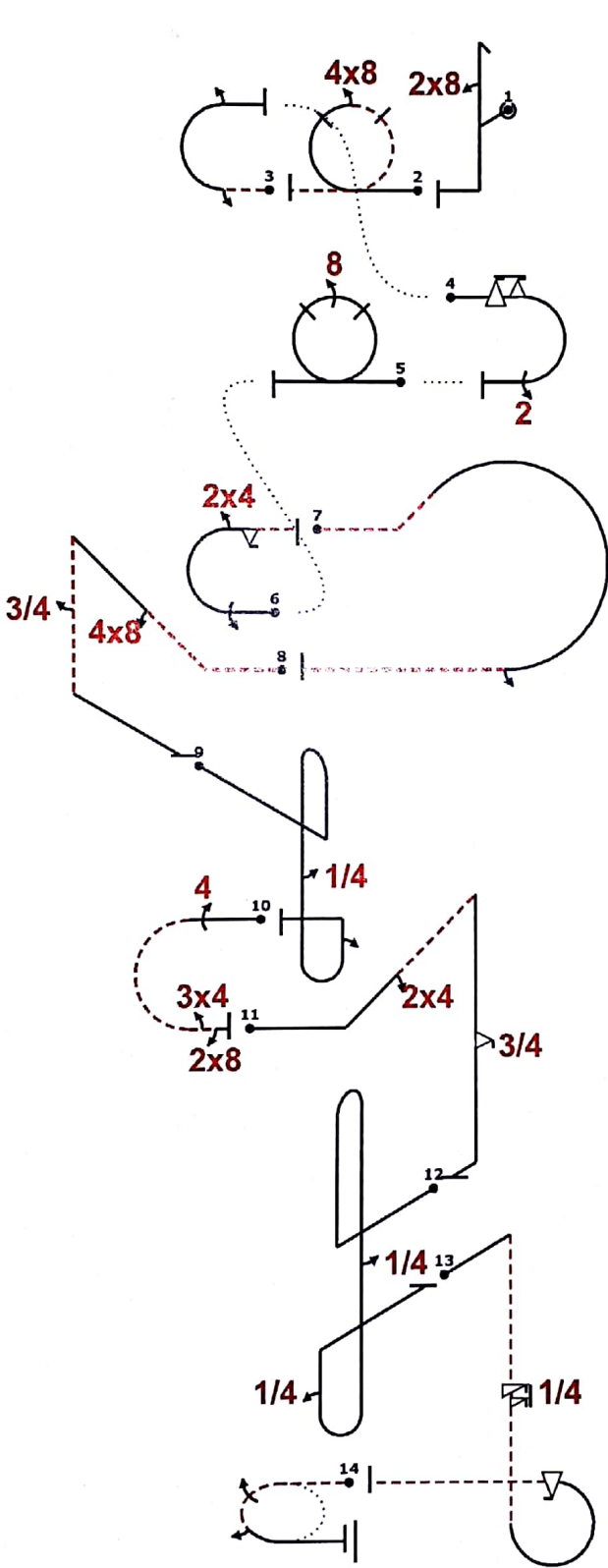

Power			
Fig 1	5.2.1.1	17	24
D	9.8.1.1	7	
Fig 2	7.4.2.1	12	19
J	9.8.3.2	7	
Fig 3	7.2.4.2	6	6
Add.	9.1.3.2	4	
	9.1.3.2	4	
Fig 4	7.2.3.3	6	29
A	9.9.3.6	14	
	9.2.3.4	9	
Fig 5	7.4.1.1	10	25
F	9.8.3.4	15	
Fig 6	7.2.1.1	6	30
C	9.1.3.4	8	
	9.4.3.2	5	
	9.9.3.2	11	
Fig 7	8.5.3.2	11	6
Add.	9.1.3.2	4	
Fig 8	1.2.4.2	14	29
E	9.8.2.2	9	
	9.1.5.3	6	
Fig 9	8.8.2.1	19	6
Add.	9.1.5.1	2	
	9.1.1.2	8	
Fig 10	7.2.2.3	8	30
G	9.4.3.4	11	
	9.4.3.3	8	
	9.8.3.1	3	
Fig 11	1.2.3.1	12	30
I	9.4.2.2	7	
	9.9.5.3	11	
Fig 12	8.8.2.1	19	6
Add.	9.1.5.1	2	
	9.1.1.1	6	
Fig 13	8.6.3.3	13	28
B	9.11.1.5	4	
	9.9.3.4	11	
Fig 14	2.2.3.4	26	26
H			
Total K = 294			

ej "00" 8h> "01" o48- "0L" -2m2 (14,18) "0A" 6fa22 (-4,0) "0F" o88 (4,22) "0C" 1m24,2F- "0L" 15%nc2....."0E" /--.'48..
t.,3.'++++ "0L" -----bb('4.',2' > "0C" 3% ,44'a'34,8- "0I" /---.,24..t...'3f..' "0L" +++..bb('4...')4++++ "0B" +++...5s.'irpf
-----> "0I" -2jo15

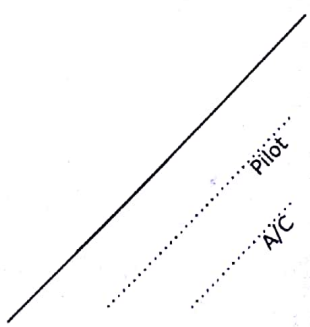

wind/vent

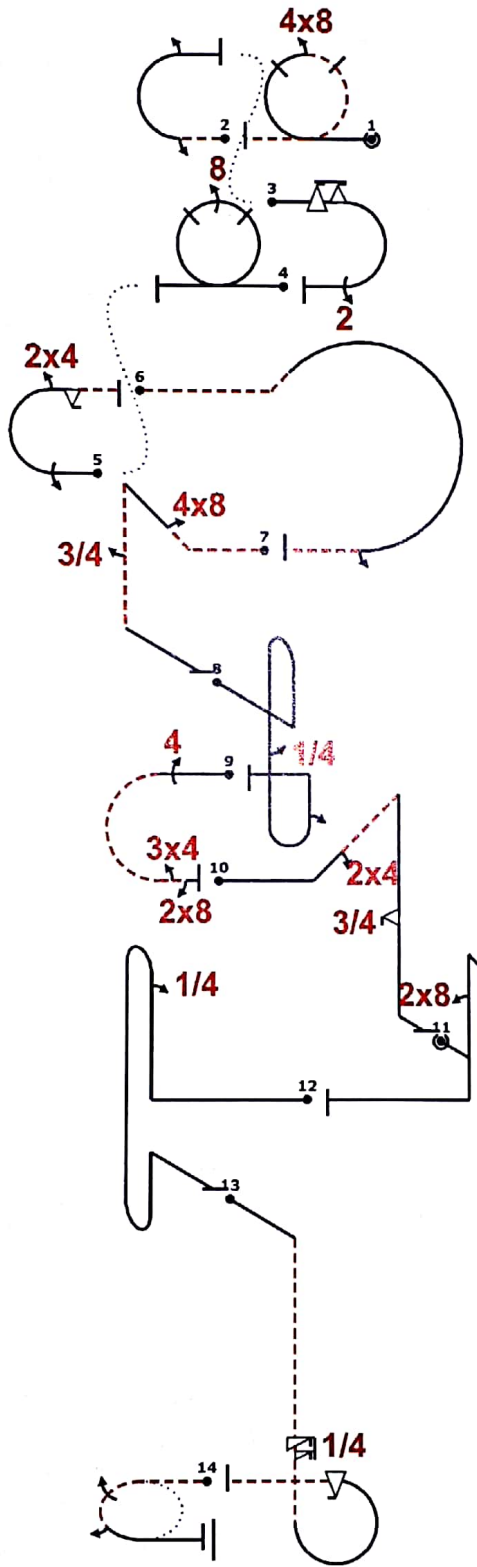

Power			
Fig 1	7.4.2.1	12	19
	9.8.3.2	7	
Fig 2	7.2.4.2	6	6
Add.	9.1.3.2	4	
	9.1.3.2	4	
Fig 3	7.2.3.3	6	29
A	9.9.3.6	14	
	9.2.3.4	9	
Fig 4	7.4.1.1	10	25
F	9.8.3.4	15	
Fig 5	7.2.1.1	6	30
C	9.1.3.4	8	
	9.4.3.2	5	
	9.9.3.2	11	
Fig 6	8.5.3.2	11	6
Add.	9.1.3.2	4	
Fig 7	1.2.4.2	14	29
E	9.8.2.2	9	
	9.1.5.3	6	
Fig 8	8.8.2.1	19	6
Add.	9.1.5.1	2	
	9.1.1.2	9	
Fig 9	7.2.2.3	8	30
G	9.4.3.4	11	
	9.4.3.3	8	
	9.8.3.1	3	
Fig 10	1.2.3.1	12	30
I	9.4.2.2	7	
	9.9.5.3	11	
Fig 11	5.2.1.1	17	24
D	9.8.1.1	7	
Fig 12	8.8.2.1	19	6
Add.	9.1.1.1	6	
Fig 13	8.6.3.3	13	28
B	9.1.1.5	4	
	9.9.3.4	11	
Fig 14	2.2.3.4	26	26
M			
Total K = 294			

ed "@j" o48- "@L" -2m2 (1,14) "BA" 6fa22 "BF" o88 (-2,18) "BC" 1m24,2f- "@L" 15% ---"rc2" ---"BE" /---",48"t.,3.+++
 "@L" ++bb(4.) ,2> "EG" 3% ,44'a'34,8+ "BI" ---,24.'t...' ,3f.' ' ej "BD" '8h' ++++ "@L" +++.,4bb(...)+ "@B" +++.....'5sirpf---> "BH"
 -2joi5

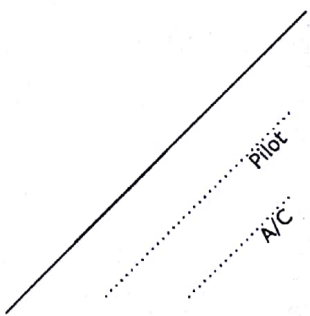

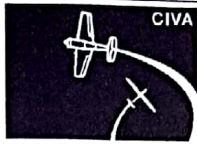

Pilot ID

Q

CIVA Advanced Unknown1

Form B

Flight #

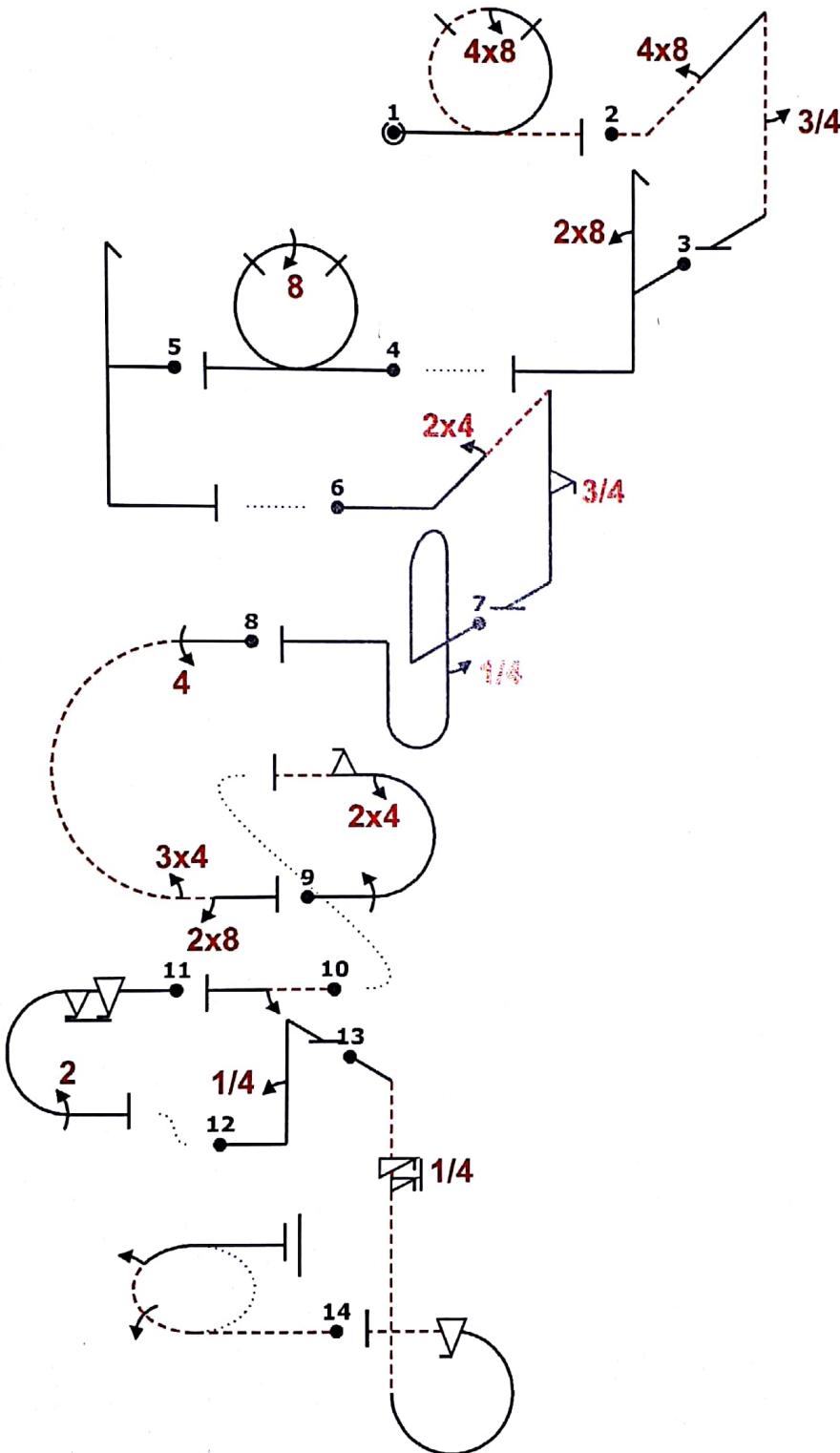
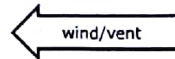

Power			
Fig 1 J	7.4.2.1 9.8.3.2	12 7	19
Fig 2 E	1.2.4.2 9.8.2.2 9.1.5.3	14 9 6	29
Fig 3 D	5.2.1.1 9.8.1.1	17 7	24
Fig 4 F	7.4.1.1 9.8.3.4	10 15	25
Fig 5 Add.	5.2.1.1	17	6
Fig 6 I	1.2.3.1 9.4.2.2 9.9.5.3	12 7 11	30
Fig 7 Add.	8.8.2.1 9.1.5.1	19 2	6
Fig 8 G	7.2.2.3 9.4.3.4 9.4.3.3 9.8.3.1	8 11 8 3	30
Fig 9 C	7.2.1.1 9.1.3.4 9.4.3.2 9.9.3.2	6 8 5 11	30
Fig 10 Add.	1.1.1.4 9.1.3.2	2 4	6
Fig 11 A	7.2.3.3 9.9.3.6 9.2.3.4	6 14 9	29
Fig 12 Add.	1.1.6.1 9.1.1.1	10 6	6
Fig 13 B	8.6.3.3 9.11.1.5 9.9.3.4	13 4 11	28
Fig 14 H	2.2.3.4	26	26
Total K = 294			

"gJ" o48- "gE" --'48''t.3''~ "g0" ~8h''~ (-4,0) "gE" o,88 "gE" h.+ (4,0) "gI" ~'24''t''3f''~ "gE" ~bb(''4'')~ "gE" 11X ''44a34,8+'' ~ "gC" 1m24,2f- (8,14) "gE" ~2 "gA" 6fa22 (2,2) "gE" /v4 "gE" /.55..''lrpf- "gI" --2jo15^

Pilot
A/C

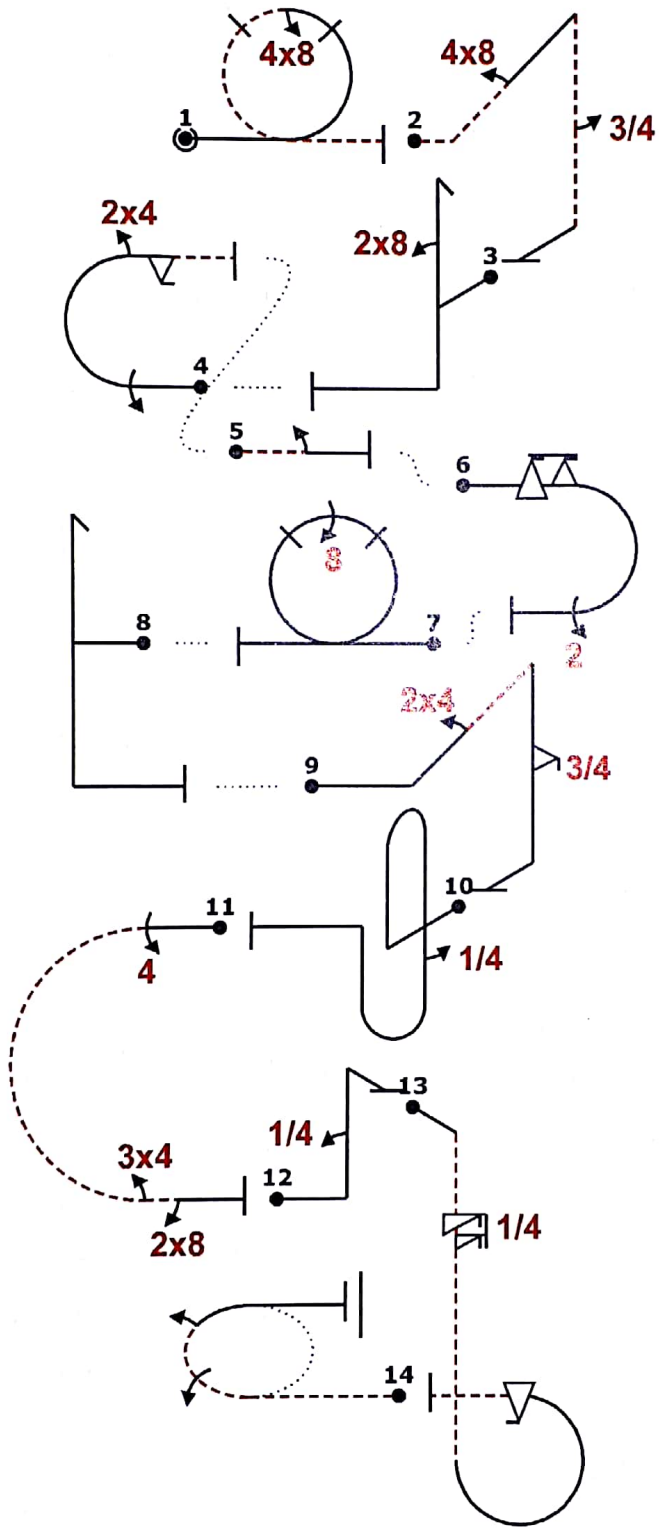
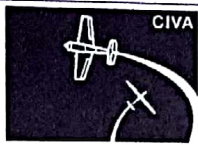

Power			
Fig 1 J	7.4.2.1 9.8.3.2	12 7	19
Fig 2 E	1.2.4.2 9.8.2.2 9.1.5.3	14 9 6	29
Fig 3 D	5.2.1.1 9.8.1.1	17 7	24
Fig 4 C	7.2.1.1 9.1.3.4 9.4.3.2 9.9.3.2	6 8 5 11	30
Fig 5 Add.	1.1.1.4 9.1.3.2	2 4	6
Fig 6 A	7.2.3.3 9.9.3.6 9.2.3.4	6 14 9	29
Fig 7 F	7.4.1.1 9.8.3.4	10 15	25
Fig 8 Add.	5.2.1.1	17	6
Fig 9 I	1.2.3.1 9.4.2.2 9.9.5.3	12 7 11	30
Fig 10 Add.	8.8.2.1 9.1.5.1	19 2	6
Fig 11 G	7.2.2.3 9.4.3.4 9.4.3.3 9.8.3.1	8 11 8 3	30
Fig 12 Add.	1.1.6.1 9.1.1.1	10 6	6
Fig 13 B	8.6.3.3 9.11.1.5 9.9.3.4	13 4 11	28
Fig 14 H	2.2.3.4	26	26
Total K = 294			

"@J" o48- "BE" "'-48''t.3''~ "0" ~8h+~ (-3,0) "EC" 1m24,2f- (-4,12) "EL" -2 (2,2) "EA" 6fa22 (-1,2) "EF" o,88 (-2,0) "EL" h.+ (4,0)
 "EI" ~'24''t''3f''~ "EL" ~bb(''4'')~ "EG" 11X''44a34,8+'' "EL" /v4 "EU" /.5s...irpf- "EH" --2j015"

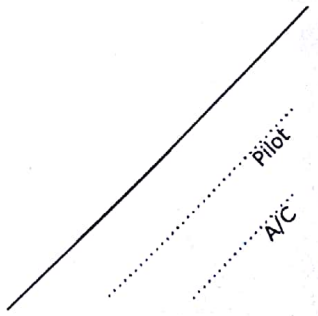



WAAC 2018		Form B
Pilot ID	CIVA Advanced Unknown1	
	Flight #	

wind/vent ←

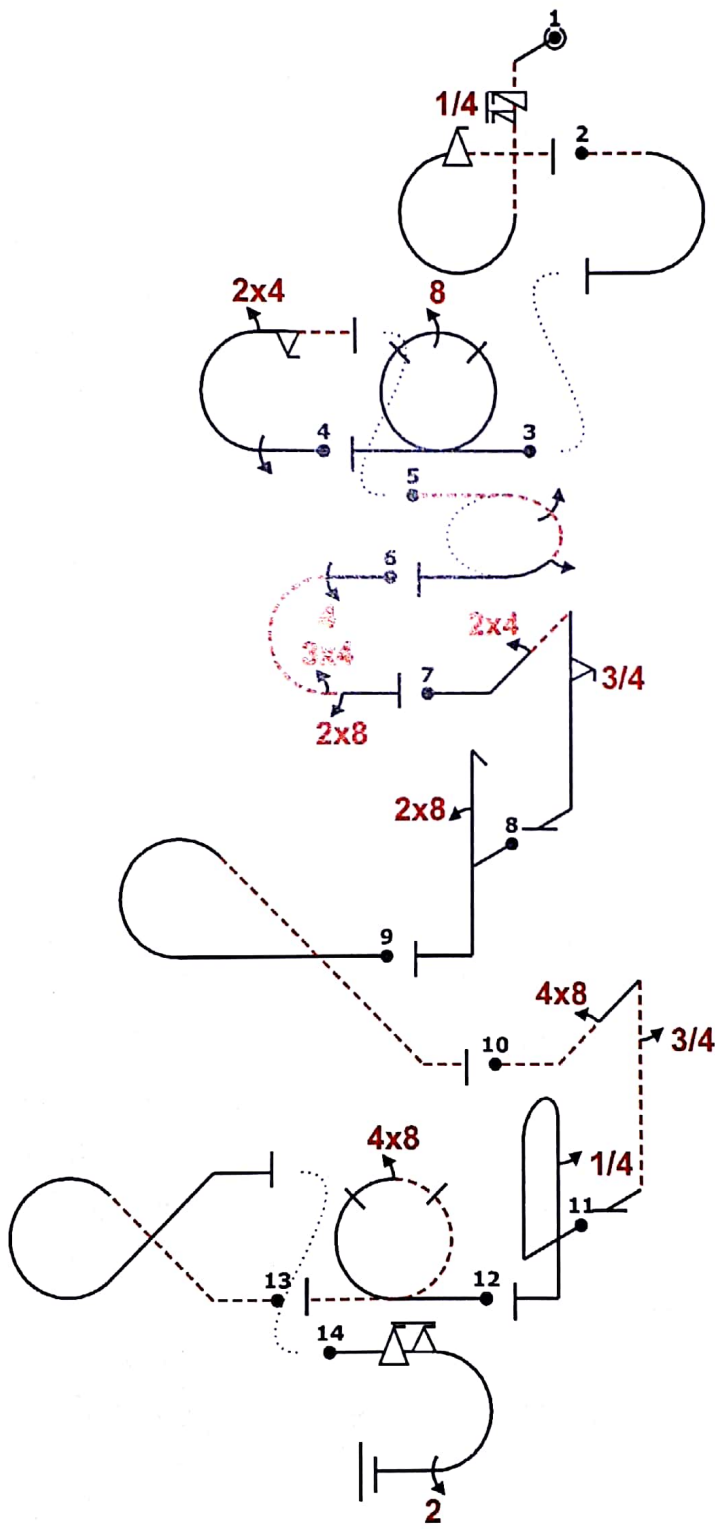

Power			
Fig 1	8.6.3.3	13	28
B	9.11.1.5	4	
	9.9.3.4	11	
Fig 2	7.2.1.4	6	6
Add.			
Fig 3	7.4.1.1	10	25
F	9.8.3.4	15	
Fig 4	7.2.1.1	6	30
	9.1.3.4	8	
	9.4.3.2	5	
	9.9.3.2	11	
Fig 5	2.2.3.4	26	26
	H		
Fig 6	7.2.2.3	8	30
	9.4.3.4	11	
	9.4.3.3	8	
	9.8.3.1	3	
Fig 7	1.2.3.1	12	30
	9.4.2.2	7	
	9.9.5.3	11	
Fig 8	5.2.1.1	17	24
	9.8.1.1	7	
Fig 9	8.5.5.1	10	6
Fig 10	1.2.4.2	14	29
	9.8.2.2	9	
E	9.1.5.3	6	
Fig 11	8.4.1.1	13	6
	Add.	2	
Fig 12	7.4.2.1	12	19
	J	9.8.3.2	
Fig 13	7.3.1.2	14	6
Add.			
Fig 14	7.2.3.3	6	29
	9.9.3.6	14	
	9.2.3.4	9	
	A		
Total K = 294			

ej "00", Ssirpf- "@L" -a (0,12) "0F" o88 "0C" 1m24,2f- (0,11) "0H" -2jo15 "0G" 44a34,28 "0I" 24t3f. "0D" 8h "0L" c... "0E" -48t3.. "0L" b... "0J" b48- "0L" -g (0,12) "0A" 6fa22

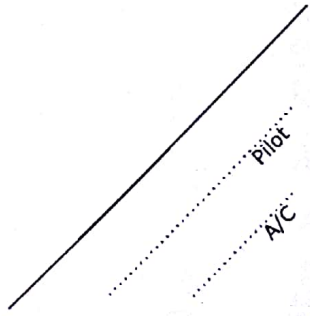

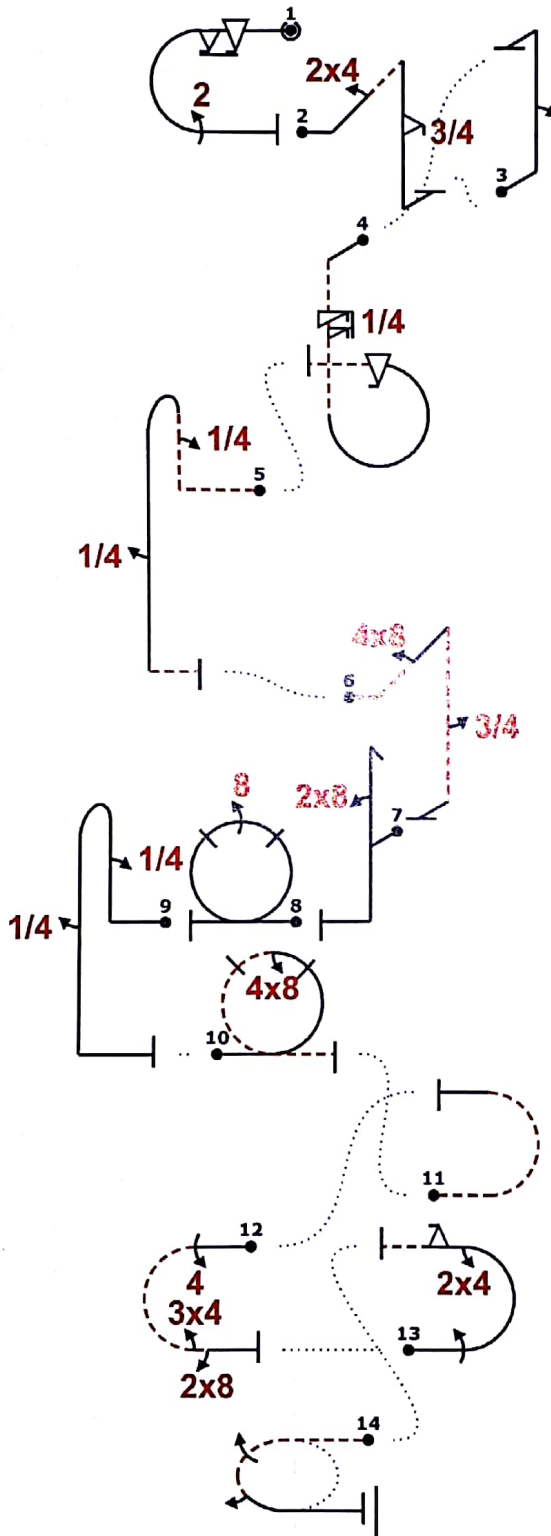

Power			
Fig 1 A	7.2.3.3	6	29
	9.9.3.6	14	
	9.2.3.4	9	
Fig 2 I	1.2.3.1	12	30
	9.4.2.2	7	
	9.9.5.3	11	
Fig 3 Add.	1.1.6.1	10	6
	9.1.1.2	8	
Fig 4 B	8.6.3.3	13	28
	9.1.1.5	4	
	9.9.3.4	11	
Fig 5 Add.	8.4.3.2	16	6
	9.1.1.1	6	
	9.1.5.1	2	
Fig 6 E	1.2.4.2	14	29
	9.8.2.2	9	
	9.1.5.3	6	
Fig 7 D	5.2.1.1	17	24
	9.8.1.1	7	
Fig 8 F	7.4.1.1	10	25
	9.8.3.4	15	
Fig 9 Add.	8.4.1.1	13	6
	9.1.1.1	6	
	9.1.5.1	2	
Fig 10 J	7.4.2.1	12	19
	9.8.3.2	7	
Fig 11 Add.	7.2.1.2	8	6
Fig 12 G	7.2.2.3	8	30
	9.4.3.4	11	
	9.4.3.3	8	
	9.8.3.1	3	
Fig 13 C	7.2.1.1	6	30
	9.1.3.4	8	
	9.4.3.2	5	
	9.9.3.2	11	
Fig 14 H	2.2.3.4	26	26
Total K = 294			

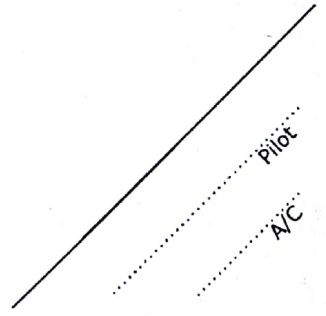

ed "a" 6f22~ "eI" "+24t'3f'^ (2,2) "eL" v',2' (-8,13) "eB" '5sirpf- (0,10) "eL" -',4b',4, ' (8,2) "eC" '-48t.'3' "eD" '+8
h "eF" '+o88+' "eL" '+,4'b',4.. (1,0) "eJ" '+o48- (4,11) "eL" -m (-11,12) "eC" 44a34,8 (8,0) "eC" 1m24,2f- (3,15) "eH" -2jo15



Pilot ID		WAAC 2018	Form B
		CIVA Advanced Unknown1	Flight #

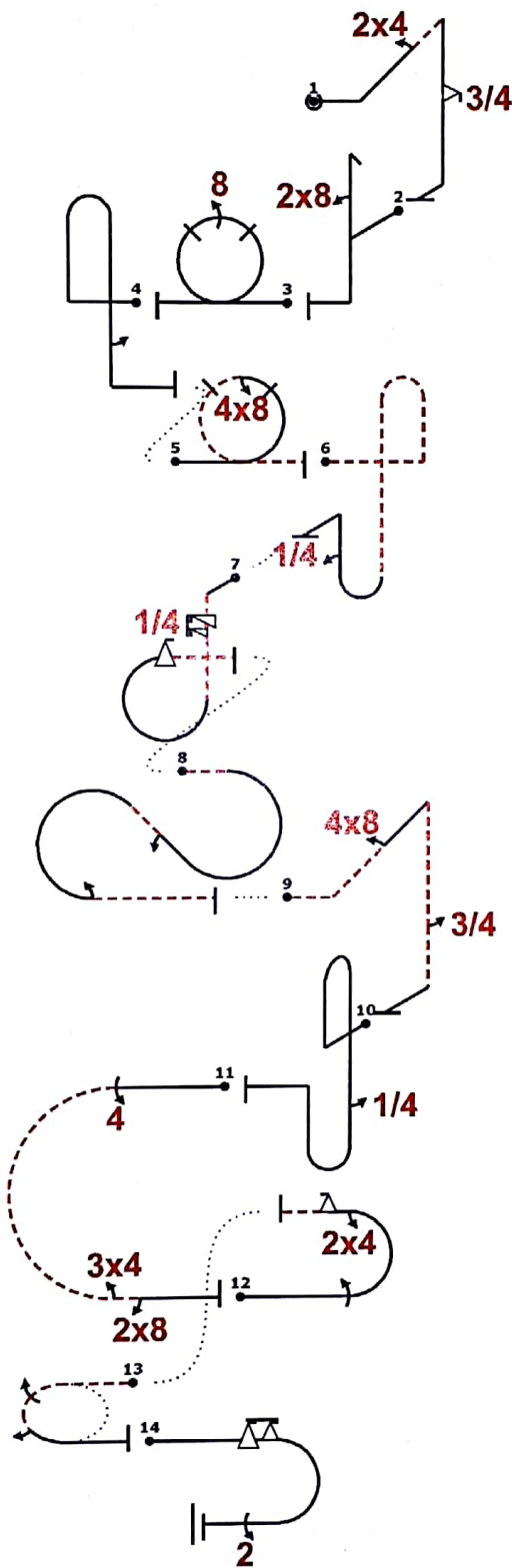

Power			
Fig 1 I	1.2.3.1	12	30
	9.4.2.2	7	
	9.9.5.3	11	
Fig 2 D	5.2.1.1	17	24
	9.8.1.1	7	
Fig 3 F	7.4.1.1	10	25
	9.8.3.4	15	
Fig 4 Add.	8.4.1.1	13	6
	9.1.5.2	4	
Fig 5 J	7.4.2.1	12	19
	9.8.3.2	7	
Fig 6 Add.	8.8.3.2	23	6
	9.1.1.1	6	
Fig 7 B	8.6.3.3	13	28
	9.11.1.5	4	
	9.9.3.4	11	
Fig 8 Add.	7.5.7.4	15	6
	9.1.2.2	5	
	9.1.3.2	4	
Fig 9 E	1.2.4.2	14	29
	9.8.2.2	9	
	9.1.5.3	6	
Fig 10 Add.	8.8.2.1	19	6
	9.1.5.1	2	
Fig 11 G	7.2.2.3	8	30
	9.4.3.4	11	
	9.4.3.3	8	
	9.8.3.1	3	
Fig 12 C	7.2.1.1	6	30
	9.1.3.4	8	
	9.4.3.2	5	
	9.9.3.2	11	
Fig 13 H	2.2.3.4	26	26
Fig 14 A	7.2.3.3	6	29
	9.9.3.6	14	
	9.2.3.4	9	
Total K = 294			

"EI" .24t.3f.' "0D" +8h "0P" o88 "0L" b..2 (-4,7) "0J" o48- "0L" --pbb(.)4 (-3,2) "0B" ,5s1rpf- (-9,11) "0L" 3%iac(2)2-...
 (3,0) "0E" -.48''t...''3''+ "0L" bb(.4) "0G" 15X 44a34,8+ "0C" ..1m24,2f- (-10,16) "0H" -2j015 "0A" .''6fa.22

Pilot
 A/C

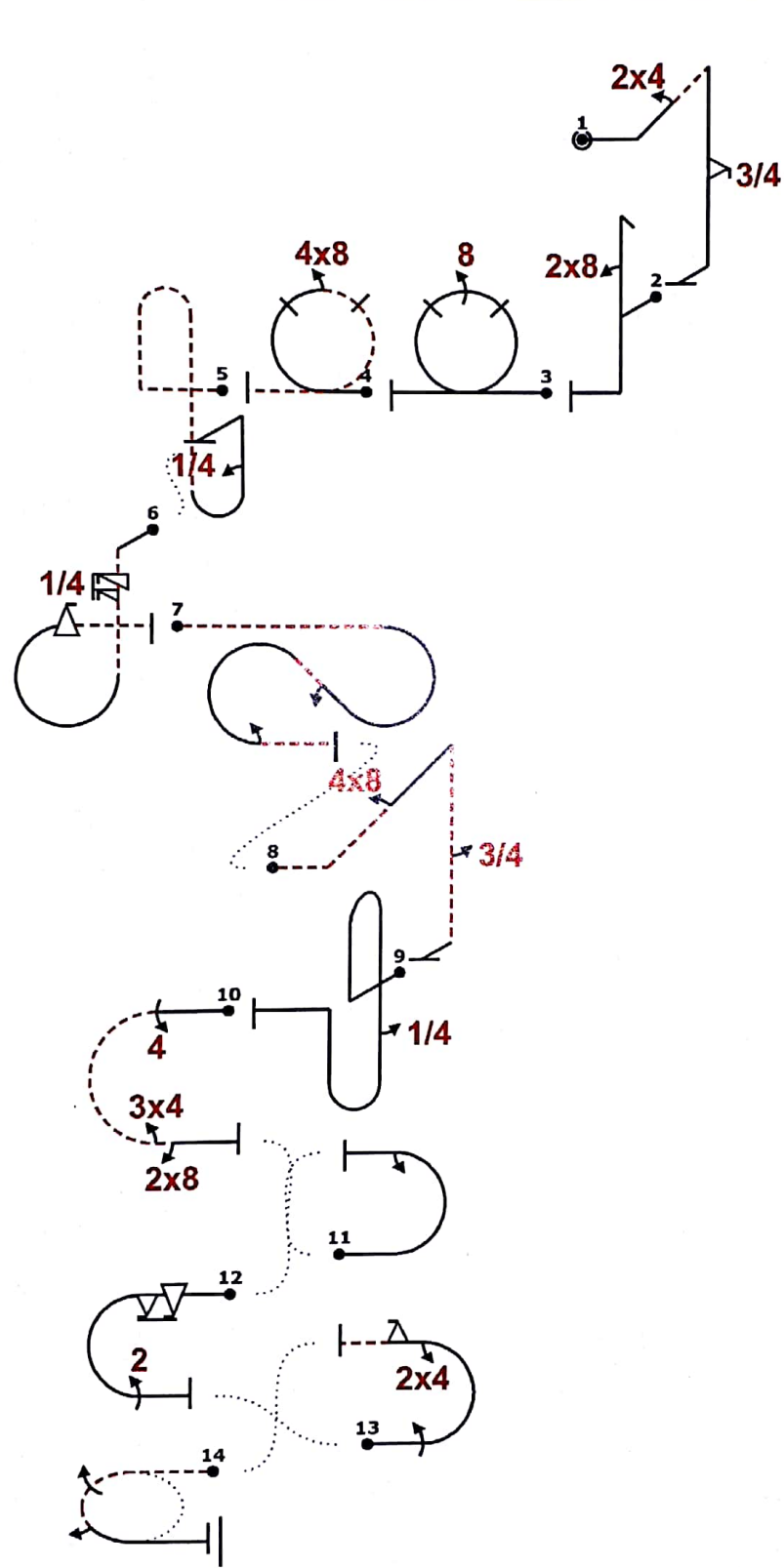

Power			
Fig 1 I	1.2.3.1 9.4.2.2 9.9.5.3	12 7 11	30
Fig 2 D	5.2.1.1 9.8.1.1	17 7	24
Fig 3 F	7.4.1.1 9.8.3.4	10 15	25
Fig 4 J	7.4.2.1 9.8.3.2	12 7	19
Fig 5 Add.	8.8.3.2 9.1.1.1	23 6	6
Fig 6 B	8.6.3.3 9.11.1.5 9.9.3.4	13 4 11	28
Fig 7 Add.	7.5.7.4 9.1.2.2 9.1.3.2	15 6 4	6
Fig 8 E	1.2.4.2 9.8.2.2 9.1.5.3	14 9 6	29
Fig 9 Add.	8.8.2.1 9.1.5.1	19 2	6
Fig 10 G	7.2.2.3 9.4.3.4 9.4.3.3 9.8.3.1	8 11 8 3	30
Fig 11 Add.	7.2.2.1 9.1.3.2	6 4	6
Fig 12 A	7.2.3.3 9.9.3.6 9.2.3.4	6 14 9	29
Fig 13 C	7.2.1.1 9.1.3.4 9.4.3.2 9.9.3.2	6 8 5 11	30
Fig 14 H	2.2.3.4	26	26
Total K = 294			

"@I" 24t."3f. "@D" 8h "@F" o88 "@J" ""+o48- "@L" -pbb()4 (0,5) "@@",5s1rpf-> "@L" -lac(2)2- (-9,10) "@E" -.48.t."3. "@L" bb (4) "@G" 3x 44a34,8 (4,9) "@L" m2 (-5,11) "@A" 6fa22 (10,4) "@C" 1m24,2f- (-6,10) "@I" -2jo15

